

FinishLynx Sports Timing

Product Catalog



LYNX



facebook.com/finishlynx



[@finishlynx](https://instagram.com/@finishlynx)



youtube.com/finishlynx



[1.800.989.5969](tel:18009895969)



sales@finishlynx.com



www.finishlynx.com

EtherLynx Vision Camera	<u>3</u>
EtherLynx Vision PRO Camera	<u>4</u>
EtherLynx Vision PRO X Camera	<u>5</u>
Camera Accessories & Upgrades	<u>6</u>
IdentiLynx & VeriLynx Camera	<u>11</u>
EtherLynx PRO Parts	<u>13</u>
Camera Lenses & Mounts	<u>14</u>
Camera Mounting Equipment	<u>16</u>
Software	<u>19</u>
Software Plug-Ins	<u>20</u>
ResultTV	<u>22</u>
Starting Equipment	<u>23</u>
Photocells	<u>28</u>
Wind Gauges	<u>31</u>
XLR/Start Cables	<u>33</u>
Ethernet Cables	<u>35</u>
Power Cables	<u>36</u>
Service	<u>37</u>
ReacTime	<u>38</u>
FieldLynx	<u>43</u>
LaserLynx	<u>45</u>
Lap & Split Timing	<u>46</u>
Timing Synchronization	<u>58</u>
Displays	<u>59</u>
Protective Cases	<u>66</u>
Computer & Computer Peripherals	<u>67</u>
Networking Hardware	<u>69</u>
Complete Packaged Solutions	<u>71</u>
Athletics (Track) Packages	<u>72</u>
Athletics (Field) Packages	<u>73</u>
IdentiLynx & VeriLynx Packages	<u>74</u>
ReacTime Packages	<u>75</u>
Cycling & BMX Packages	<u>76</u>
Rowing & Regatta Packages	<u>77</u>
Speed Skating Packages	<u>78</u>
Open Water Swimming	<u>80</u>

EtherLynx Vision Camera

5L500



Powerful Features & Add-Ons

 **EasyAlign** - Full-frame video mode makes camera alignment easier than ever.

 **Full-Color** - All Vision cameras come standard with the ability to capture color images.

 **Silent Operation** - The Vision runs silently thanks to reduced power consumption and no fans.

 **Wi-Fi [Upgrade]** - Connect a small, external Wi-Fi unit to wirelessly transfer timing & results data.

 **LuxBoost™ [Upgrade]** - Amplifies available light for better race images in low-light conditions.

 **High-Resolution [Upgrade]** - Provides captures up to 2,000 fps with up to 1,280 pixels of height.

 **Electronic Viewfinder [Upgrade]** - Connect a video viewfinder to the HDMI port for alignment.

 **Power-Over-Ethernet** - All Vision cameras can draw power via the Ethernet cable.

 **Gigabit Transfers** - The first EtherLynx camera to allow for Gigabit Ethernet transfers (1,000 Mbps).

 **Advanced Power Control** - New power controls ensure the best power source in each situation.

 **Onboard Level** - Monitor the camera's level and orientation directly from FinishLynx.

 **Electronic Filter Control [Upgrade]** - Users can enable/disable low-light filters from FinishLynx.

 **Internal Battery Backup [Upgrade]** - Battery pack allows the camera to withstand power loss.

 **Video Display Module [Upgrade]** - Send live results from camera to HDMI-connected display.

EtherLynx Vision PRO Camera

5L600



Elite-Level Photo-Finish Camera Features

 **High-Speed Capture** – Comes standard with **3,000** fps. Optional upgrades enable **6,000 & 20,000** fps.

 **EasyAlign** - Full-frame video mode makes photo-finish camera alignment easier than ever.

 **LuxBoost™** - Amplifies available light for better race images in low-light conditions.

 **Backwards Compatible** - The Vision PRO is compatible with all Lynx cameras sold since 1996.

 **Electronic Filter Control** - Users can enable or disable low-light filters from FinishLynx.

 **Internal GPS [Upgrade]** - Sync with GPS times for use with Motorsports and Time of Day events.

 **High-Resolution [Upgrade]** – High-Res. provides **6,000** or **20,000** fps captures at **2048** pixels high.

 **Wi-Fi [Upgrade]** – Connect a small, external Wi-Fi unit to wirelessly transfer timing & results data.

 **Power-Over-Ethernet** – Provide camera power and data transfers from a single Ethernet cable.

 **Gigabit Transfers** - Capture large images quickly with Gigabit Ethernet transfers (1,000 Mbps).

 **Advanced Power Control** - New power controls ensure the best power source in each situation.

 **Onboard Level** - Monitor the camera's level and orientation directly from FinishLynx.

 **Phased Light Compensation [Upgrade]** – Helps reduce dark lines caused by artificial lighting

 **Video Display Module [Upgrade]** - Send live results from camera to HDMI-connected display.

 **Electronic Viewfinder [Upgrade]** – Connect a video viewfinder to the HDMI port for alignment.

 **Internal Battery Backup [Upgrade]** - Battery pack allows the camera to withstand power loss.

EtherLynx Vision PRO X Camera

5L700



Advanced Features

Perfect For

Extended Time Accuracy: Up to 40,000 fps

High Velocity Sports & High Resolution Images

Extended Resolution: Up to 5120 Pixels High

Wide Finish Lines & High Resolution Images

Extended Light Sensitivity: Up to LuxBoost 16

Events Under Artificial Lighting

Extended Choice of F-Mount Lenses

High-Quality Lens Options (F-Mount Adapter Included)

Extended Features: Inclusive of Most Possible Options

Adding GPS, Level, EVF, PLC, LuxBoost, Frame Offset, etc.



Camera Accessories & Upgrades

Capture Button

1A205B



Capture Button without cord or USB to Serial Converter

Capture Button & 5.9' Cord

1A205USB



Capture Button and 5.9 foot USB Cord

Connection Box

C-Box2



Retains form and functionality of the original C-Box while adding a second photo eye input for use with multiple photo eye configurations.

Ext. Wireless

Ext_WiFi



For EtherLynx & Vision Cameras, Includes AirLynx Gateway (8L101)

Ext. Wireless

Ext_WiFi2



For EtherLynx & Vision Cameras. Does not include AirLynx Gateway (8L101)

Vision Series AC/DC and DC in Power Supply Kit

VisionPSKit



We are sorry but there is currently no image available for this product.

www.lynx.com 401-318-0962

Includes a 25' AC(110/220) to DC (12vdc, 1.6A) Power Supply and a DC pigtail input assembly

Camera Accessories & Upgrades

Plexiglass Cover

Vision-CVR



We are sorry but there is currently no image available for this product.



For EtherLynx Vision Series

Electronic View Finder Package

5LVision-EVF1



For Vision-series. Includes View Finder, battery, charger, Power Supply, Clamp and HDMI cable

Internal RadioLynx Receiver

INT-DEC-004



We are sorry but there is currently no image available for this product.



Includes Antenna. For Vision-series Cameras

Electronic Filter Option

5LEF



For Vision-series. Electronically enable/disable low-light filters from FinishLynx software

Electronic View Finder (EVF)

5LEVF

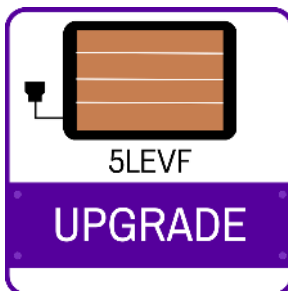

For Vision-series. Allows external display to be connected to camera HDMI port for local viewing during alignment.

High Resolution Option

5LHR



Allows Enhanced Scan Rate of 2000 by Pixel Density of 1000 for the EtherLynx Vision cameras.

Camera Accessories & Upgrades

Internal Camera Battery

5LBatt

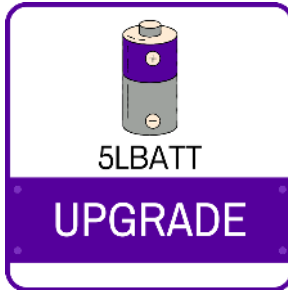

Internal battery pack allows the camera to withstand power loss. For Vision-series.

Internal Camera Level

5LLevel



Monitor the camera's level and orientation from FinishLynx software. For Vision-series.

Internal GPS Synchronizer

5LGPS



Includes Antenna. For Vision-series. 5LPES not required.

LuxBoost™ Level 4

5LLUX4



Amplifies available light for better race images in low-light conditions. For Vision Series

LuxBoost™ Level 8

5LLUX8



Amplifies available light for better race images in very low-light conditions. For Vision Series

LuxBoost™ Upgrade

LuxUpgrade8



Amplifies available light for better race images in very low-light conditions. For Vision-series Lux4 to Lux8.

Camera Accessories & Upgrades

Timer Enabling Option

5LTE



Enables events to be timed on all EtherLynx & Vision cameras across the network.

Video Display Option

5LVDM



Allows configurable graphics display of scoreboard data via direct HDMI connection. For Vision-series.

Wireless Option

5LWIFI



For EtherLynx Cameras includes AirLynx Gateway 8L101.

Wireless Option

5LWIFI2



Does not include AirLynx Gateway (8L101)

Extended Resolution & Zoom

5LZOOM



Allows use of smaller focal length lenses & extends vertical resolution of EtherLynx PRO up to 4000 pixels. Ideal for applications where camera is far from the finish line/ with wide finish lines (rowing/canoeing).

Frame Rate Upgrade from 3kfps to 5kfps

5L5K



Upgrade for Vision PRO only. Includes "RAM1GB" memory upgrade to 1Gbyte.

Camera Accessories & Upgrades

Frame Rate Upgrade from 3kfps to 10kfps

5L10K



Upgrade for Vision PRO only. Includes "RAM1GB" memory upgrade to 1Gbyte

Frame Rate Upgrade from 5kfps to 10kfps

5L5K10K



Upgrade for Vision PRO only.

5L600 Vertical Res. Increase

5L600Zoom



From 1024 to 2048 pixels. Upgrade for Vision PRO only.

VisionPro Upgrade fps: 3K to 20K

5L20K



Upgrade for Vision PRO only.

VisionPro Upgrade fps: 6K to 20K

5L6K20K



Upgrade for Vision PRO only.

IdentiLynx & VeriLynx

IdentiLynx SR-2 Video Camera

IDL SR-2



2D full-frame video camera for use with FinishLynx Software. Max Resolution 1920x1080, Max Rate 30fps

IdentiLynx HRS Video Camera

IDL-HRS



Full Frame video camera for use with FinishLynx Software. Max Resolution 3264x1840, Max Rate 60fps

VeriLynx V30 Camera

VER-V30



Full Frame video camera for use Foot Foul Visualization with FinishLynx Software.

VeriLynx V60 Camera

VER-V60



Full Frame video camera for use Foot Foul Visualization with FinishLynx Software.

Power-over-Ethernet

IDL-PoE



30Watt, 56Volts

CS Mount Lens

IDL-CS8.5-50f1.6



We are sorry but there is currently no image available for this product.

www.finishlynx.com/Support 400-338-0962

For use with IdentiLynx cameras.

8.5-50mm f1.6

100' CAT6 w/ RJ45

WPCAT6-100



We are sorry but there is currently no image available for this product.



Connectors, weatherproof hood at one end

Weatherproof hood for RJ45 connector

WPCN-RJ45



We are sorry but there is currently no image available for this product.



Spare External Power Supply

5L300PS



Rain Guard

5L300RG



Waterproof fabric cover for EtherLynx PRO camera.

Lens Mounts & Lenses

Manual Zoom C-Mount Lens

155



Manual zoom, focus and iris control. 12.5-75mm f1.2.

Remote Controlled Zoom C-Mount Lens

C1275M



Allows for Remote Controlled zoom, focus and iris.12.5-75mm f1.2

C-Mount 8-48mm Manual Lens

C848



C-Mount 8-48mm Motorized Zoom Lens

C848M



CS-Mount 2.8-10mm P-Iris

CS2810P



CS-Mount to C-Mount Adapter

MCS-C



F-Mount Adapter

MV-R



We are sorry but there is currently no image available for this product.



Allows for Remote Controlled Iris of F-Mount lenses on Vision Pro cameras.

F-mount Adapter

MV-RF



We are sorry but there is currently no image available for this product.



Allows for Remote Controlled Iris and Remote Control Focus of F-Mount lenses on Vision Pro cameras.

F-Mount 50-100mm f/1.8 Lens

SI5010018DCN



We are sorry but there is currently no image available for this product.



Remote Iris Only

Camera Mounting Equipment

Remote Positioner

2L102



Allows remote positioning of camera's pan, tilt and swivel motion from the computer.

Swivel Tilt Head

BG3232



Allows swivel and tilt adjustment, useful with 2L200P Camera Mounting Post.

Super Head Clamp

BG2909



When used with tripod head, mounts camera to any pole or board

Geared Mounting Head

BG3275



Attaches to tripod or super clamp and allows horizontal, vertical & swivel adjustment of camera.

Heavy-Duty Geared Mounting Head

BG3263



Attaches to tripod or super clamp and allows horizontal, vertical & swivel adjustment of camera.

Quick Release Plate

BG3271



Replacement quick release plate for the 3275 geared head.

Camera Mounting Equipment

Micro Positioning Plate

BG3419



Attaches between camera and mounting head to allow fine horizontal adjustment.

Reversible Stud for Super Head Clamp

BG2907



Medium Duty tripod

BG394



We are sorry but there is currently no image available for this product.



Heavy Duty Tripod w/ Leveling Guide

BG3036



74" Camera Tripod with Leveling Guide

Heavy Duty Tripod with Leveling Guide

TP-105



We are sorry but there is currently no image available for this product.



105" Camera Tripod with Leveling Guide

Heavy Duty Crank-Up Camera Stand

B200



Heavy Duty 152" Crank-Up Camera Stand w/ Wheels

Camera Mounting Post

2L200P

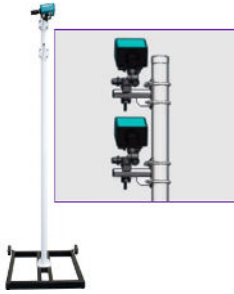

Camera mounting post made from 4" aluminum with heavy wheeled base. One 12' high section.

FinishLynx32 Software License

5LSW

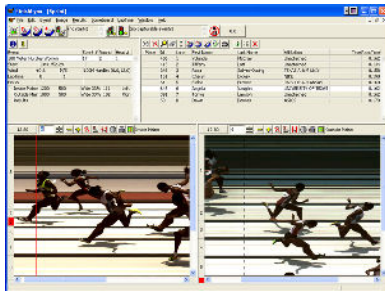

Advanced Software with Database Integration - Windows9x/NT /2000/XP/Vista platform.

LynxPad Meet Management Software

9LSW01

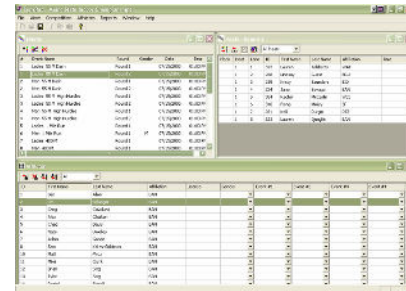

Multi-lingual software for creating FinishLynx and FieldLynx database files as well as importing and printing start lists and results. Includes many seeding options, multi-event scoring, cross-country scoring, and scoreboard interface.

XCSCORE Software

730156



XCSCORE is a Windows application that calculates team scores for Cross Country events in real-time, based on the split or results data received from FinishLynx, and sends these scores to scoreboards or video displays connected to ResultTV

FinishLynx Plug-Ins

Auto Capture Plug-In (ACM)

5LACM



Allows any EtherLynx camera to act as a photo eye and send pause & stop signals to running clocks. Also allows automatic capture of any object moving across the finish line.

External Synchronization Plug-In

5LPES



Allows synchronization with external timing devices including GPS based devices

LapTime Plug-In

5LLAP



Enables FinishLynx to accept split times from external devices (e.g. transponders and Chronometers)

Lynx Data Port Plug-In

5LPLDP



Remote applications to access FinishLynx event data over the network. LDP is meant for programmers with specific objectives such as streaming image frames or analyzing them using AI technology. It can also be used to poll FinishLynx for the event status.

Multi-Split Plug-In

5LSPLIT



Allows recording of multiple splits within the same FinishLynx event using a single or multiple cameras.

RadioLynx Plug-In

5LPRL



Allows use of RadioLynx wireless start and photocell with FinishLynx.

Time Trial Plug-In

5LPPT



Allows FinishLynx to operate in Time Trial Mode where starts can be assigned to individual athletes.

Portable-VDM

PortVDM



An integrated display solution that combines ResultTV-VDM running on a battery-powered Windows Mini-PC in a weatherproof connection box

ResultTV Software (Broadcast Version)

ResultTV-BR



Broadcast version suppresses Lynx Logo. When Combined with a Scan Converter, allows Results and Running Time to be displayed dynamically to CCTV and other TV output display devices. Connects via network or serial port to any PC running FinishLynx.

ResultTV (Broadcast Version) Upgrade

ResultTV-BR_Upgrade



We are sorry but there is currently no image available for this product.



Upgrade to ResultTV-U or -P

ResultTV Software License with USB HW key

ResultTV-U



Configurable graphics application allowing results and running time data to be dynamically displayed on LED video screens, CCTV, and other TV devices via an HDMI output. Supports network or serial port to any PC running FinishLynx, FieldLynx or LynxPad.

ResultTV-VDM Software License

ResultTV-VDM



We are sorry but there is currently no image available for this product.



ResultTV-VDM is a simplified version of ResultTV. Like the VDM option for Vision-series cameras, the content of the ResultTV-VDM layout is controlled by the data received (e.g. from FinishLynx or FieldLynx)

Starting Equipment

Electronic Starting System

3L500V2



Electronic "gun" generates a flash and an electronic gun sound or tone through a single large speaker. Comes with a headset to allow starting commands to run through the speaker as well. Can be used wired or with RadioLynx.

Electronic Start Speaker Kit

3L500SK

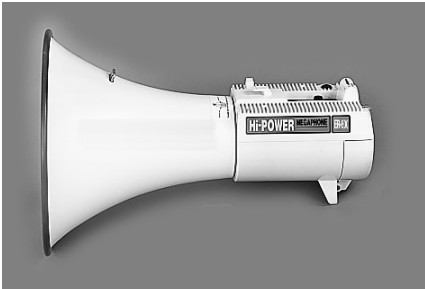

Used to add up to three additional speakers to Electronic Starting System.

Electronic Starting System Plus

3L501US



Electronic Starting System Plus - Europe

3L501EU



Electronic Start System Plus - UK

3L501UK



Spare Gun for Electronic Starting System

PS-78X



Starting Equipment

Normally Open Start Sensor for RadioLynx

3L300R



Only for use with RadioLynx Transmitter.

Normally Open Start Sensor

3L300



Normally Closed Start Sensor w/ Ready Light

3L400



Nylon Mount

3L-Mount



For attaching gun sensor to starter's gun.

RadioLynx Wireless Start System

3L900



Includes RadioLynx transmitter, receiver, power supply & one 3L300R sensor. Range of up to 800m.

Extended Range RadioLynx Wireless Start System

3L900E



Includes RadioLynx long-range transmitter, receiver, power supply & one 3L300R sensor. Range of up to 5km.

Starting Equipment

Belt Clip Kit for RadioLynx Transmitter

8L-Clip



Power Supply

8L-PS-12V



For RadioLynx, ReacTime and SerialLynx

Spare antenna for Internal RadioLynx Receiver

ANT-433MR



We are sorry but there is currently no image available for this product.

www.lynx.com.au [1300 130 000](tel:1300130000)

Spare Headset for Electronic Starting System

HS-9



Internal RadioLynx Start System

Int-3L900



We are sorry but there is currently no image available for this product.

www.lynx.com.au [1300 130 000](tel:1300130000)

Ext. Range Internal RadioLynx Start System

Int-3L900E



We are sorry but there is currently no image available for this product.

www.lynx.com.au [1300 130 000](tel:1300130000)

Vision-series only. Includes Internal RadioLynx transmitter (Factory installed in Vision Camera), receiver, power supply & one 3L300R sensor. Range of up to 800m.

Vision-series. Includes Internal RadioLynx receiver (Factory installed in Vision Camera), transmitter, power supply & one 3L300R sensor. Range of up to 5km.

Starting Equipment

Start Gate w/ Double Contact (FIS) and Bar

MG-ACC032



RadioLynx Receiver

MG-DEC004



One receiver can accept start and photocell signals from multiple transmitters.

RadioLynx Receiver Serial Cable

MG-DEC004-Serial



Spare antenna for RadioLynx

MG-ELA009



RadioLynx Transmitter

MG-ENC004



Particularly useful for placing a wireless photocell at the 200m point.

RadioLynx Transmitter and Power Supply

MG-ENC004R



We are sorry but there is currently no image available for this product.



Extended Range RadioLynx Transmitter

MG-ENC204



Mini Tripod

7LTP



Useful for mounting photocell or reflector.

Wireless Photocell Kit

ACC033K



Includes long range single beam photocell, reflector, two tripods, banana cube adapter and radio transmitter.

Wireless Photocell Kit - Short Range

ACC093K



Includes short range single beam photocell, reflector, two tripods, banana cube adapter and radio transmitter.

Ground Level Photocell Tripod

BG-3007K2



We are sorry but there is currently no image available for this product.

Multiple phone numbers: 400-570-0869

Allows photocell or reflector to be mounted at ground level.

Long Range, Single Beam Photocell

MG-ACC033



Rechargeable, single beam photocell. 30 meter optical range

Reflector for Long Range, Single Beam Photocell

MG-ACC034



Photocells

Banana Cube Adapter

MG-ACC054



Allows radio transmitter to be mounted to photocell.

Support for Double Photocell/Reflector

MG-ACC083



Allows two photocells or reflectors to be mounted in the same plane.

Short Range, Single Beam Photocell

MG-ACC093



Rechargeable, single beam photocell. 15 meter optical range

Double Photocell Kit (15m Range)

MG-ACC093D



Includes two 15m range single beam photocells, two reflectors, two tripods and two double mounting supports and double photocell cable

Single Photocell Kit (15m Range)

MG-ACC093S



Includes one 15m range single beam photocell, one reflector, two tripods, mounting supports and photocell cable.

Reflector for Short Range, Single Beam Photocell

MG-ACC094



Photocells

Photocell holder

MG-ACC123



We are sorry but there is currently no image available for this product.

www.lynx.com 400-576-0969

Cable for Double Photocell

MG-CAB119



Allows two photocells to be connected in serial to produce one signal when both beams are broken

Photocell Input Cable - 15 feet long

PE-Input



Wind Gauges

Weather Proof Wind Gauge

WG-Lynx



For use with FinishLynx. Includes tripod, case, DC Power Cord and 200' cable.

Weather Proof Wind Gauge

WG-Lynx-SA



For use with FL and standalone use. Includes: Complete WG-Lynx & WG-SA-CTRL standalone controller unit

Includes WG-Lynx-SA, 7LBATT & C-LynxWG-Batt

WG-Lynx-SA-B



We are sorry but there is currently no image available for this product.

WOLF FINISH LYNX 400-538-0902

WG-Lynx Input cable

C-LynxWG-Input



We are sorry but there is currently no image available for this product.

WOLF FINISH LYNX 400-538-0902

Cable only

Includes WG-Lynx, 7LBATT & C-LynxWG-Batt

WG-Lynx-B



We are sorry but there is currently no image available for this product.

WOLF FINISH LYNX 400-538-0902

Cable for WG-Lynx to External Battery

C-LynxWG-Batt



We are sorry but there is currently no image available for this product.

WOLF FINISH LYNX 400-538-0902

Cable only

Wind Gauges

Includes 7LBatt & C-LynxWG-Batt

EXTBatt_WGLX



We are sorry but there is currently no image available for this product.



4-Digit LED Display & Countdown Timer

E39820



Connects directly to wind gauge. Battery operated. Tripod included.

Standalone Controller

WG-SA-CTRL



For WG-Lynx for use with Field Events

XLR/Start Cables

XLR-3 Start Cable - 500 foot

3A100



3 conductor 24 awg shielded cable, 500 feet long, with XLR-3 male and female connectors.

Facility Starting System

3A200



Multiple reel cabling system for an outdoor 400m facility. Allows starter to simply plug the start sensor into an "outlet" near each of the four corners of the track.

XLR-3 Start Cable - 10 foot

C43-10



3 conductor 24 awg shielded cable 10 feet long, with XLR-3 male and female connectors.

XLR-3 Start Cable - 25 foot

C43-25



3 conductor 24 awg shielded cable 25 feet long, with XLR-3 male and female connectors.

XLR-3 Start Cable - 50 foot

C43-50



3 conductor 24 awg shielded cable 50 feet long, with XLR-3 male and female connectors.

XLR-3 Start Cable - 100 foot

C43-100



3 conductor 24 awg shielded cable 100 feet long, with XLR-3 male and female connectors.

XLR/Start Cables

XLR-3 Start Cable - 200 foot

C43-200



3 conductor 24 awg shielded cable 200 feet long, with XLR-3 male and female connectors.

XLR-3 Start Cable - 300 foot

C43-300



3 conductor 24 awg shielded cable 300 feet long, with XLR-3 male and female connectors.

Ethernet

Network Cable - 25'

C10BT-25



With RJ45 Connectors

Network Cable - 100'

C10BT-100



With RJ45 Connectors

Network Cable - 200'

C10BT-200



With RJ45 Connectors

Network Cable - 300'

C10BT-300



With RJ45 Connectors

Power Cables

25' US Power Cable

452



25' US Power Cord

USPwr25-WR



We are sorry but there is currently no image available for this product.



Water Resistant conn for LXLED

25' European Power Cable

Euro-Power



We are sorry but there is currently no image available for this product.



Euro Power Cord

EuroPwr25-WR-75M



We are sorry but there is currently no image available for this product.



Water Resistant conn for LXLED

Camera Diagnostics

TR10



A complete physical and electrical camera check-up including timer accuracy certification.

1 Year Extended Product Warranty

XTWRNT_1Y



Price varies with items purchased

3 Year Extended Product Warranty

XTWRNT_3Y



Price varies with items purchased

2 Year Extended Product Warranty

XTWRNT_2Y



Price varies with items purchased

World Athletics Certified Starting Blocks

730155



ReactTime Serial Cable

7L-SERIAL



Connects Command Center to ReactTime computer serial port.

ReactTime Signal Input Cable

7L-SIGNAL



Allows connection of devices such as gun sensors and photocells to a Block Sensor.

ReactTime Input Splitter

7L-SPLITTER



Allows a single gun sensor on start button to activate 2 block sensors.

Block Sensor

7L100



Attaches to most manufacturer's starting blocks. This sensor can be used for training or competition. Measures athlete's reaction time and relative power out of the blocks.

Spare ReactTime Internal Battery

7L100-B



We are sorry but there is currently no image available for this product.

www.reacttime.com 401-338-0902

ReactTime Training Case

7L100TC



Block Mounted Speaker

7L102



False Start Command Center

7L103



Connects up to 10 Block Sensors to create a complete False Start Detection and Reaction Time System.

Block Sensor Clamp

7L105

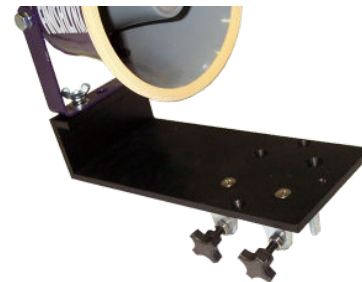

Starter's Headset

7L106



ReactTime Line Printer

7L107



#DPU414 - Uses paper roll # SS112-25A

Block Sensor Cable (5.5meter)

7L108



Command Center Cable (30 meter)

7L108CC



Block Sensor Cable (13meter)

7L108L



One Lane Photo eye Kit

7L109



Includes tripods and 50' cable.

ReactTime Start Button

7L205



External Battery Pack for ReactTime Block Sensor

7LBATT



False Start Operating & Storage Unit

7LCART



We are sorry but there is currently no image available for this product.



ReactTime System Case

7LFSC



Holds 6 Block Sensors.

ReactTime Power Supply & Charger

7LPWR



Allows charging of up to 10 block sensors simultaneously.

Speaker Case

7LSC



Holds 4 Block Mounted Speakers.

ReactTime Championship Software License

7LSWFS

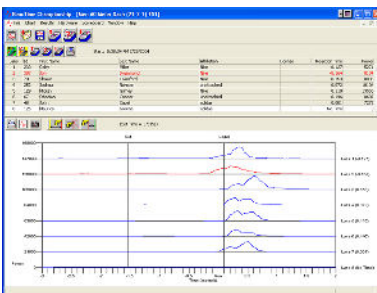

Allows the analyzing, storing and printing of reaction time and relative power traces downloaded from the Command Center. Can be used to send reaction times to FinishLynx for inclusion in the data flow. Windows9x/NT/2000/XP/Vista platform.

ReactTime Training Software License

7LSWTR

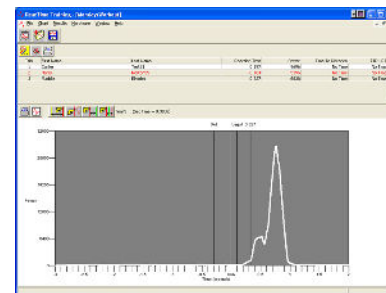

Allows the analyzing, storing and printing of reaction time, time-to-distance and relative power traces downloaded from one or more block sensors. Windows9x/NT/2000/XP/Vista platform.

Short Range, Single Beam Wireless Photocell

MG-ACC089



Rechargeable, single beam photocell with internal radio transmitter. 15 meter optical range - Not compatible with RadioLynx.

Receiver: Short Range, Single Beam Photocell

MG-DEC005



Only for use with MG-ACC089 - Not compatible with RadioLynx.

uCom Headset Amplifier

MG-TEL003



We are sorry but there is currently no image available for this product.



Paper roll for ReacTime DPU414 Printer

SS112-25A



We are sorry but there is currently no image available for this product.



(Part# 7L107)

ClerkLynx Site License

6LSW_CL



We are sorry but there is currently no image available for this product.



1 Seat for use with NetExchange

FieldLynx Site License

6LSW_FL



We are sorry but there is currently no image available for this product.



1 Seat for use with NetExchange

FieldLynx Scoreboard/Printer Interface Plug-In

6LSW1



Site License. Allows FieldLynx to transfer results information to ResultTV, scoreboard displays and FieldLynx printer.

FieldLynx Wind Gauge Software Plug-In

6LSW2



Site license. Allows FieldLynx to communicate with a Wind Gauge

FieldLynx LaserLynx Plug-In Site License

6LSW3



Allows connection of LaserLynx EDM directly to FieldLynx.

Net Exchange Server license (w/ USB HW Key)

6LSW7U



We are sorry but there is currently no image available for this product.



NetExchange Server allows FieldLynx, ClerkLynx and AirCyber applications to retrieve and send Lynx Database files to the competition management computer.

FieldLynx Lite for Windows

6LSW8



We are sorry but
there is currently no
image available for
this product.



Includes WG, Laser & SB. Allows field interfacing to WG-Lynx, WG-Sonic, Lasers & Scoreboards

Netbook

6LWinNet



Windows OS, USB Ports, Wired/Wireless Ethernet

Complete LaserLynx Pro III Package

6L209



Laser based electronic distance measurement (EDM) system. Meets or exceeds World Athletics accuracy requirements. Includes tripod, prism, prism pole, on-board battery and data cable.

Spare Prism Kit

MPU1



Spare Prism Pole

PC21



Spare Data Cable

S50660



For LaserLynx Pro II, Pro III and HS II

Spare Battery

S62005



For LaserLynx Pro III, Pro II, LaserLynx HS II

Spare Aluminum Tripod

TS50F



Lap & Split Timing

ProChip Timer Go (unit)

10R170



ThinTag

10S084



BibTag

10S085



We are sorry but there is currently no image available for this product.

www.mylaps.com/lynx [400-538-0962](tel:400-538-0962)

ProChip Decoder with Cabling

15S061



Bibtag Portable Decoder 8M US

15S017_1



We are sorry but there is currently no image available for this product.

www.mylaps.com/lynx [400-538-0962](tel:400-538-0962)

LinkPod Pushbutton

1A209LAP



Lap & Split Timing

Orbits Cycling software

25R030

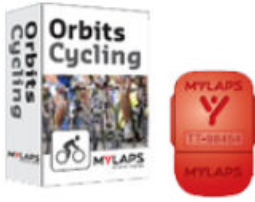

100m/330ft 75 Ohm coax with 2 BNC connectors

30R027AS



We are sorry but there is currently no image available for this product.



ProChip detection loop 6m (5m coax)

30R061



ProChip detection loop 9m (5m coax)

30R062



ProChip detection loop 12m (5m coax)

30R063



ProChip detection loop 16m (5m coax)

30R064



Lap & Split Timing

ProChip detection loop end box with loop wire of 6M/9M/12M

30R066



End box with loop wire of 6M/9M/12M

Set ProChip Detection Loops

30R069



We are sorry but there is currently no image available for this product.



End box (6m/9m/12m loop wire)

ProChip Connection Box w/ 20m Coax

30R090



We are sorry but there is currently no image available for this product.



ProChip Detection Loop Box

30R091



We are sorry but there is currently no image available for this product.



With 16m loop wire

ProChip Connection Box

30R094



We are sorry but there is currently no image available for this product.



With 50m coax

ProChip Connection Box

30R095



We are sorry but there is currently no image available for this product.



With 100m coax

ProChip Coax T-splitter

30R100



We are sorry but there is currently no image available for this product.

www.lynx.com 400-578-0969

Prochip Mat

30R200



BibTag detection mat (rubber)

30S032



BibTag Side Antenna

30S038



EasyMat 4M

30S061



(US, AUS, MY, CN, JP)

EasyMat 6M

30S065



(US, AUS, MY, CN, JP)

EasyMat Cart

30S062



Ankle strap ProChip FLEX

40R115



USB Transponder Tester

40R117AS



We are sorry but there is currently no image available for this product.



ProChip Communicator

40R121



We are sorry but there is currently no image available for this product.



Start button

40R316



We are sorry but there is currently no image available for this product.



Start button cable (BibTag+Prochip)

40R317



We are sorry but there is currently no image available for this product.



Lap & Split Timing

Start button cable (ProChip Portable Decoder)

40R323



We are sorry but there is currently no image available for this product.



Battery Cable with Car Plug

40S090



We are sorry but there is currently no image available for this product.



Battery Cable with Clamps

40S091



We are sorry but there is currently no image available for this product.



BibTag antenna tester

40S112



We are sorry but there is currently no image available for this product.



BibTag USB Reader

40S115



We are sorry but there is currently no image available for this product.



Raincover Bibtag

40S117



We are sorry but there is currently no image available for this product.



Lap & Split Timing

USB Modem ProChip Smart Decoder

40S122



We are sorry but there is currently no image available for this product.

www.lynx.com.au 400-138-0962

Powercable with angled socket (EU)

40S213



We are sorry but there is currently no image available for this product.

www.lynx.com.au 400-138-0962

Bibtag Cable Set 4m

40S214



We are sorry but there is currently no image available for this product.

www.lynx.com.au 400-138-0962

Bibtag Cable Set 8m

40S215



We are sorry but there is currently no image available for this product.

www.lynx.com.au 400-138-0962

Powercable with angled socket (US)

40S216



We are sorry but there is currently no image available for this product.

www.lynx.com.au 400-138-0962

BibTag Coax 2m/red/nr1

40S409



We are sorry but there is currently no image available for this product.

www.lynx.com.au 400-138-0962

BibTag Coax 3m/red/nr2

40S410



We are sorry but there is currently no image available for this product.



BibTag Coax 4m/red/nr3

40S411



We are sorry but there is currently no image available for this product.



BibTag Coax 5m/red/nr4

40S412



We are sorry but there is currently no image available for this product.



BibTag Coax 6m/red/nr5

40S413



We are sorry but there is currently no image available for this product.



BibTag Coax 7m/red/nr6

40S414



We are sorry but there is currently no image available for this product.



BibTag Coax 8m/red/nr7

40S415



We are sorry but there is currently no image available for this product.



BibTag Coax 9m/red/nr8

40S416



We are sorry but there is currently no image available for this product.



Bibtag Coax Side Antenna

40S420



We are sorry but there is currently no image available for this product.



1 per SideAntenna needed

Complete 4M Easy Deployment

4M-EasyMat



We are sorry but there is currently no image available for this product.



RFID Timing for XC

Complete 4M Mat

4M-MA-BibSys



We are sorry but there is currently no image available for this product.



RFID Timing for Cross Country

Complete Side Antenna RFID Timing for Track

4M-SA-BibSys



We are sorry but there is currently no image available for this product.



Complete RFID Split Timing for Track/XC

4MXTrack



We are sorry but there is currently no image available for this product.



Complete 6M Easy Deployment

6M-EasyMat



We are sorry but there is currently no image available for this product.



RFID Timing for XC

Complete 8M Mat RFID Timing

8M-MA-BibSys



We are sorry but there is currently no image available for this product.



For Wide Finish Lines

Paper Roll for REI2 and REI Pro

MG-ACC067



We are sorry but there is currently no image available for this product.



Acts as a LapTime device in a FinishLynx system or can be run standalone with a variety of internal programs. Includes REI PRO, Transport Case, Battery Charger, USB Cable, Power Cable and Paper Rolls

LinkPod with 8 Inputs

MG-ACC073



Allows 8 switch inputs to REI2. Up to 10 can be connected in serial.

Battery Charger for REI2

MG-ACC075



3 Button Keypad with 10m Cord

MG-ACC107



Amplified LinkPod with 8 Inputs

MG-ACC173



One required for longer range applications such as rowing/canoeing.

REI Pro - Active GPS Antenna

MG-ACC258



We are sorry but there is currently no image available for this product.



Battery Charger for REI Pro

MG-ACC275



We are sorry but there is currently no image available for this product.



Transport Case

MG-BAG055



We are sorry but there is currently no image available for this product.



426x290x159mm for REI Pro

Cable REI2-LinkPod, 20 meter

MG-CAB086



Cable REI2-LinkPod, 5 meter

MG-CAB092



Cable LinkPod-LinkPod, 2.6m

MG-CAB094



REI PRO Programmable Chronometer

MG-REI301



We are sorry but
there is currently no
image available for
this product.



Acts as a LapTime device in a FinishLynx system or can be run standalone with a variety of internal programs.

REI PRO Chronometer Kit

MG-REI301K



We are sorry but
there is currently no
image available for
this product.



Acts as a LapTime device in a FinishLynx system or can be run standalone with a variety of internal programs. (REI PRO, Case, Charger, Cables & Paper)

External Synchronization Kit

MG-SYN001_K



We are sorry but
there is currently no
image available for
this product.



Includes MG-SYN001, bag, power supply, power cable and data cable

Displays

Lynx Portable Display

Port_Dsply

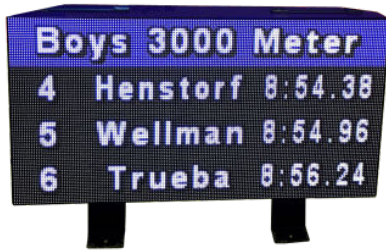

High Resolution, 0.5 SQM, LED Video display. Works with 5LVDM, ResultTV, ResultTV-Connect & HDMI-Extender

Lynx Portable Display Kit

KPort_Dsply



Includes Port_Dsply, travel/shipping case, angled & flat display stand feet, water resistant (HDMI & Power) cables, 50' HDMI cable & USB programming cable.

Lynx Single Level Round Display

Lynx360_Dsply1



Single level Lynx Display for 360-degree visibility in stadiums

Lynx Double Level Round Display

Lynx360_Dsply2



Double Level Lynx Display for 360-degree visibility in stadiums.

Infield Display & Frame - 1 Sided

fld-dsply_1S



High Resolution, 2.0 SQM, LED Video display. Works with 5LVDM, ResultTV, ResultTV-Connect & HDMI-Extender. Upgradeable to 2 or 3 sided. Wheel Assy Available, see (Fld_Dsply_WA_1S)

Infield Display & Frame - 2-Sided

Fld_Dsply_2S



High Resolution, 2.0 SQM per side, LED Video display. Works with 5LVDM, ResultTV, ResultTV-Connect & HDMI-Extender. Upgradeable to 3-sided, Wheel Assy available, see (Fld_Dsply_WA)

Infield Display & Frame - 3-Sided

Fld_Dsply_3S



High Resolution, 2.0 SQM per side, LED Video display. Works with 5LVDM, ResultTV, ResultTV-Connect & HDMI-Extender. Wheel Assy available, see (Fld_Dsply_WA)

Universal Display Foot Set

FLT-LXLEDFeet



We are sorry but there is currently no image available for this product.



For Level/Flat Mounting - LXLED

Wheel Assembly Kit

Fld_D1S_WA



We are sorry but there is currently no image available for this product.



For single-sided Infield Video Display.

Wheel Assembly - 2-Sided Display

Fld_Dsply_WA_2



We are sorry but there is currently no image available for this product.



Wheel Assembly for 2-sided display

Wheel Assembly - 3-Sided Infield Displays

Fld_Dsply_WA



We are sorry but there is currently no image available for this product.



6" 6-Digit LED Double Sided Display (90-264V)

12076XLC-RD



Running time clock for use with FinishLynx or standalone. Includes 50' serial cable and internal battery. Uses TS02 stand.

Displays

6" 6-Digit LED Display (90-264V)

6076XLC-RD



Running time clock for use with FinishLynx or standalone. Includes 50' serial cable and internal battery. Uses TS02 stand.

9" 6-Digit LED Double Sided Display (90-264V)

12079XLC-RD



Running time clock for use with FinishLynx or standalone. Includes 50' serial cable and internal battery. Uses TS02 stand.

9" 5-Digit LED Display (90-264V)

5079XLC-RD



Running time clock for use with FinishLynx or standalone. Includes 50' serial cable and internal battery. Uses TS02 stand.

9" 6-Digit LED Display (90-264V)

6079XLC-RD



Running time clock for use with FinishLynx or standalone. Includes 50' serial cable and internal battery. Uses TS02 stand.

Angled Field Display Mount, 60" Wide

DisplayMount



Ideal for field mounting of larger LED and reflective displays

Angled Field Display Mount, 36" Wide

DisplayMount-36



We are sorry but there is currently no image available for this product.



Ideal for field mounting of smaller LED and reflective displays

2-Digit Single-Sided Lap Counter 15m

LAP2-15-1



We are sorry but there is currently no image available for this product.



Includes bell, internal battery and charger. w/ Tripod, Stand & Case

2-Digit Single-Sided Lap Counter

LCB2-25-1



Includes bell, internal battery and 100-240V charger. 25cm with Tripod

2-Digit Three-Sided Lap Counter 25cm with Tripod

LCB2-25-3



Includes bell, internal battery and 100-240V charger.

3-Digit Three-Sided Lap Counter 25cm with Tripod

LCB3-25-3



Includes bell, internal battery and 100-240V charger.

Microtab LED 48V Power Supply

MG-ACC147



For Microtab and Microtab Lite

Micrograph LED 48V Power Supply

MG-ACC161



Wi-Fi Option: Microtab/Micrograph LED Displays

MG-ACC164



2 Button Keypad

MG-ACC167



We are sorry but there is currently no image available for this product.



Micrograph LED Carry Bag

MG-BAG035



Microtab LED Carry Bag

MG-BAG036



For Microtab and Microtab Lite

Bag for 3-Sided Lap Counter

MG-BAG038



We are sorry but there is currently no image available for this product.



60' Cable Display Board to PC

MG-CAB010



Power Cable

MG-CAB156



We are sorry but there is currently no image available for this product.



For Utab, UGraph LED Displays & REI301K

Microtab LED Display

MG-TAL002

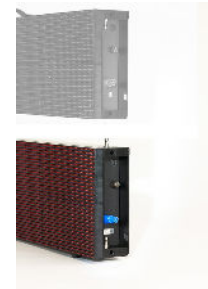

Intelligent, vertical module connection system. 16X96 LED Matrix Display board

Micrograph LED Display

MG-TAL003



Intelligent, vertical & horizontal module connection system. 32x128 LED Matrix Display board

Microtab 3 Face LED Lap Counter Display

MG-TAL004



10" 7-Digit LED Display for Field Events

TI-2021



Alternates between three digits of competitor ID plus attempt number and performance in metric or imperial. Works with FieldLynx. Can also be used as a running time clock with FinishLynx or standalone.

Display Tripod Stand

TS02



Can be used stationary or rotating.

Displays

Microtab LED Kit

UtabLED



16X96 Display - Intelligent connection

Includes: Display, power supply, internal battery, data cable & carry case

Microtab LED 3-Sided Lap Counter Display Kit

UtabLED_3S



Includes: Display, power supply, internal battery, keypad & carry case

VeriLight

VLight-A



This Ethernet device can be managed from VeriLynx, FinishLynx or FieldLynx & serves as a multi-purpose, remote-controlled, indicator light.

Protective Cases

Large Carrying Case with Wheels

1A204L



Large accessory carrying case with wheels

Custom Camera Carrying Case

1A207



Carrying case for EtherLynx cameras with custom foam insert.

Heavy Duty Custom Carrying Case – Small

CP102



Protective case for remote positioner, IdentiLynx and other smaller devices.

Heavy Duty Custom Carrying Case – Medium

SE520



We are sorry but there is currently no image available for this product.



Protective case for IdentiLynx and other mid-size devices.

Travel/Shipping Case for Lynx Portable Display

Port_Dsply_CS



We are sorry but there is currently no image available for this product.



Computers & Computer Peripherals

Notebook PC

4SX-25N



Notebook PC with FinishLynx or Meet Management software loaded and preconfigured.

Premium Quality Ink Jet Printer

INKJET



Laser Printer 1200 DPI

Laser-600



Uninterruptible Power Supply

OMNI-675



Line-Interactive 675VA Battery Back-Up system. Includes surge and brown-out protection

Uninterruptible Power Supply

UPS-200



Line-Interactive 200VA Battery Back-Up system. Includes surge and brown-out protection

USB to Serial Converter 1 Port

USB-Serial1



Converts a computer's USB port to one DB9 male serial port.

USB to Serial Converter-2 Port

USB-Serial2



Converts a computer's USB port to two DB9 male serial ports.

12v Power Plug to Dual Sockets

12vPWRSplitter



We are sorry but there is currently no image available for this product.

www.hyperlink.com 400-576-0969

12v 10A with LED Indicator. For splitting 12v power supply to multiple accessory devices

AirLynx Gateway

8L101



Allows wireless WiFi devices to connect to a wired network and NetExchange.

AirLynx Amplified Antenna Kit

8L105



Amplified 14 dbi 120 degree sector antenna kit to extend the range of the AirLynx Gateway.

Directional Antenna

8L107



External 15.5 dbi flat planar array antenna.

SerialLynx (Wired/Wireless)

8L110



Allows wired or wireless communication to two serial devices on a LAN using TCP-IP mapping.

SerialLynx (Wired/Wireless) w/ External Batt. Pack

8L110-B



Allows wired or wireless communication to two serial devices on a LAN using TCP-IP mapping. Includes SLA Battery pack for operation without AC power.

8-Port 10/100 Power over Ethernet Switch

PoE-Switch



Actual Model May Vary

Complete Packaged Solutions

FinishLynx photo-finish sports timing packages are trusted by racing events across the world, including former Olympic venues across three sports. Lynx timing systems first gained popularity as the most trusted provider of photo-finish cameras for Athletics (Track & Field) events. Today, FinishLynx offers fully automatic race timing systems for almost any sport with a finish line, including Cycling, Rowing, Horse Racing, Greyhound Racing, Speed Skating, Motorsports, and more.

We understand that your sports timing needs will vary depending on the sport and size of your races. That's why our sales team can help you build a custom photo-finish timing system to meet the needs of your venue and budget. We also offer a variety of packaged solutions for every sport.

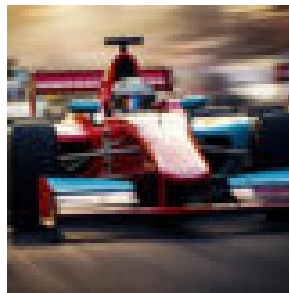
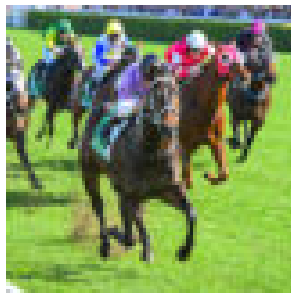
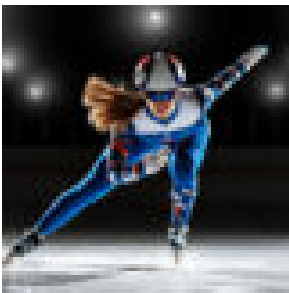
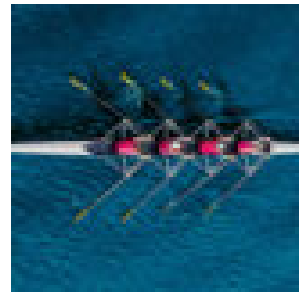
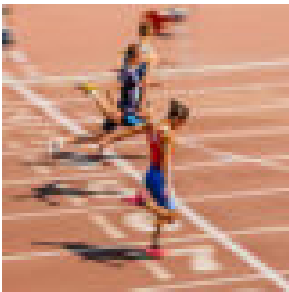

IdentiLynx & VeriLynx Packages

IdentiLynx SR Package



Includes Camera, integrated lens, tripod, PoE adapter, cables, carrying case and software

IdentiLynx HRS Package



Includes Camera, integrated lens, tripod, PoE adapter, cables, carrying case and software

VeriLynx Package - Bronze

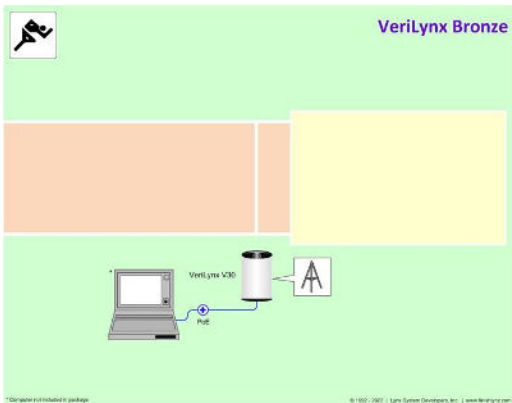

Includes camera, lens, tripod, PoE adapter, cables, carrying case and software

VeriLynx Package - Silver

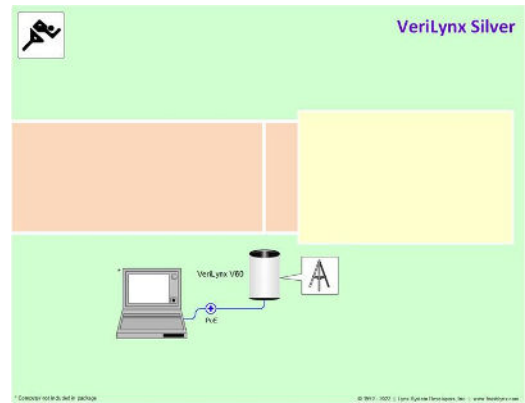

Includes camera, lens, tripod, PoE adapter, cables, carrying case, software & 5LNCP

VeriLynx Package - Gold

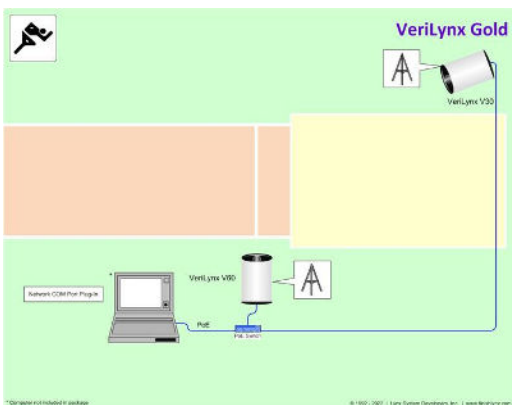

Includes 2x (camera, lens, tripod, PoE adapter, cables, carrying case), software, 5LNCP and PoE Switch

ReactTime Packages

ReactTime Training System - Starter System

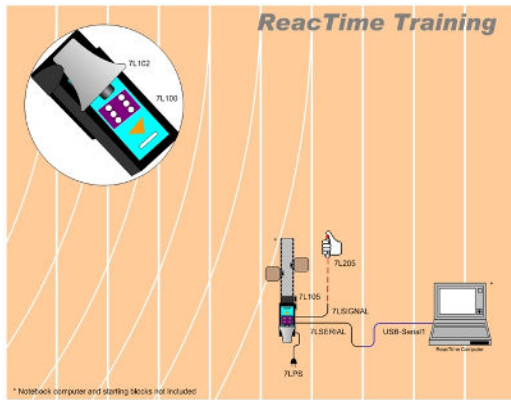

ReactTime Training System – Advanced

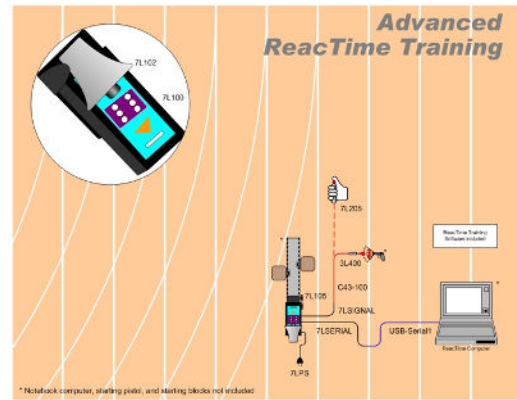

Includes RT-T system plus start sensor and PC interface software.

ReactTime Training System - Advanced Wired

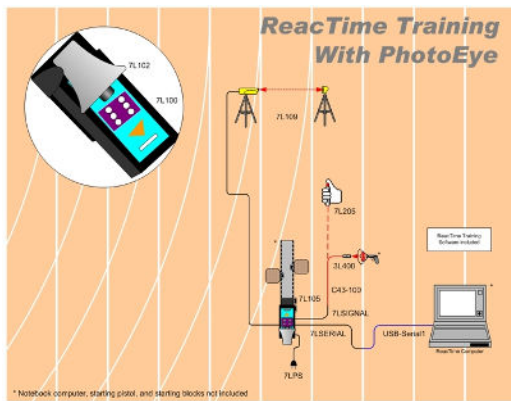

Includes RT-TA system and wired photocell

Complete 6 lane ReactTime False Start System - Wired

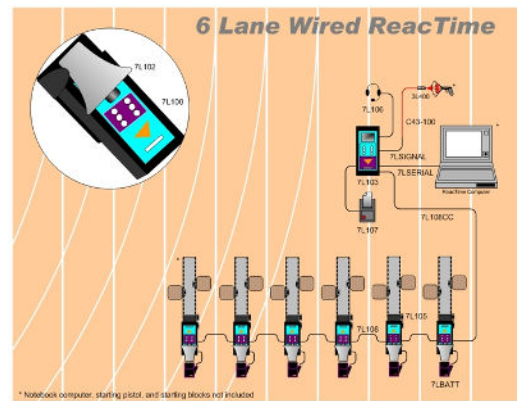

Complete 8 lane ReactTime False Start System - Wired

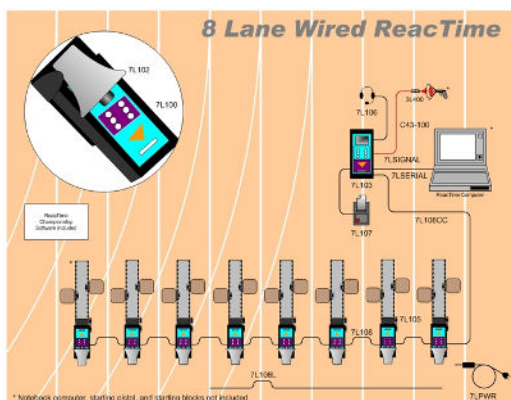

Additional ReactTime wired lane

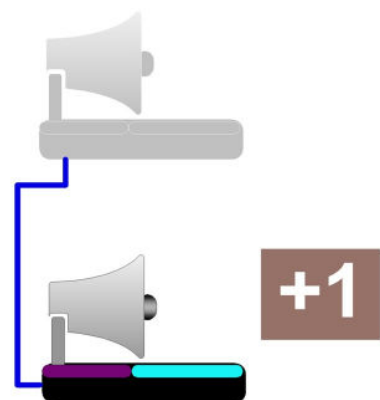

Adds a single wired lane to RT6L, system max =10. Also useful as a spare lane.

Cycling & BMX Packages

Bronze Level BMX Cycling Package

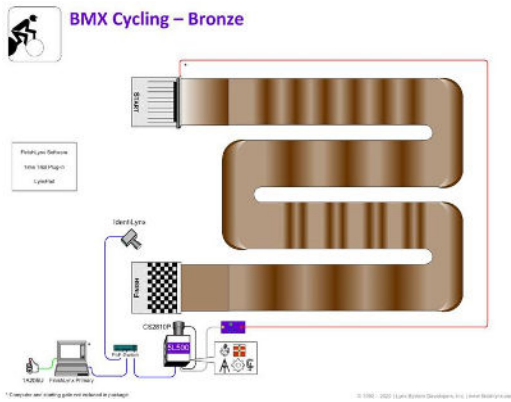

Complete system addressing the needs of BMX Cycling applications.

Silver Level BMX Cycling Package

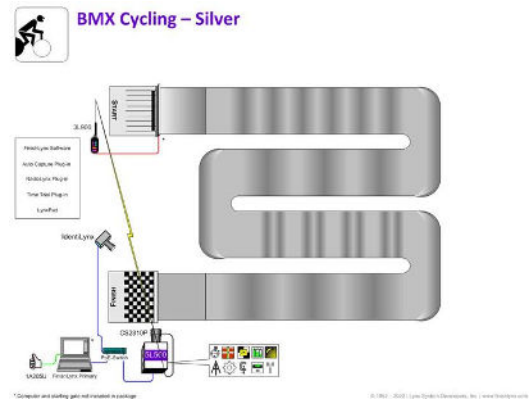

Complete system addressing the needs of BMX Cycling applications.

Gold Level BMX Cycling Package

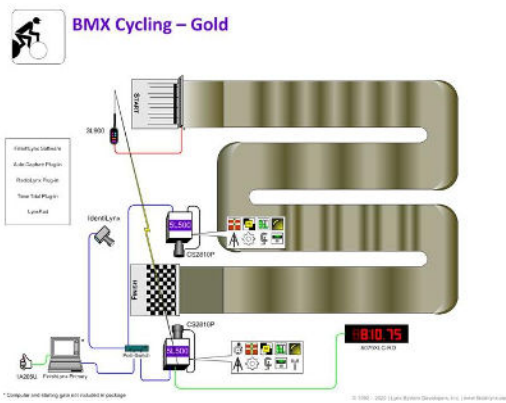

Complete system addressing the needs of BMX Cycling applications.

Bronze Level Road Cycling Package

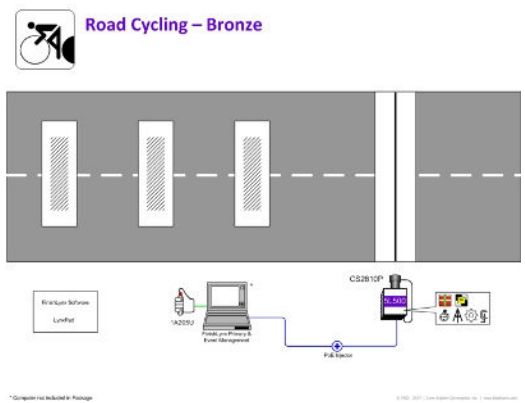

Complete system addressing the needs of Road Cycling applications.

Silver Level Road Cycling Package

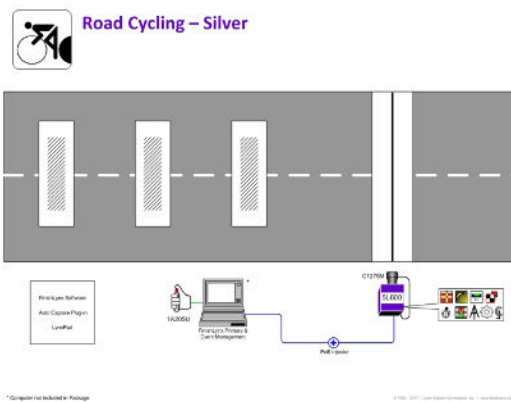

Complete system addressing the needs of Road Cycling applications.

Gold Level Road Cycling Package

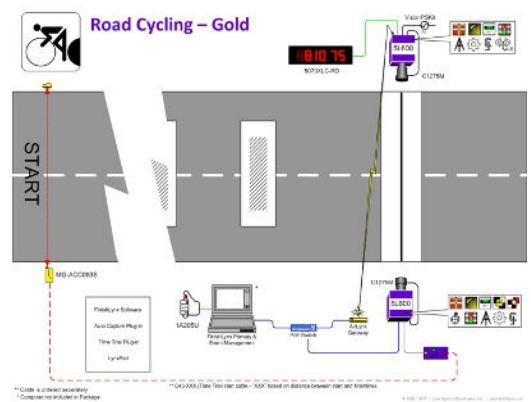

Complete system addressing the needs of Road Cycling applications.

Rowing & Regatta Packages

Bronze Level Rowing Package



Rowing - Canoe - Kayak – Bronze

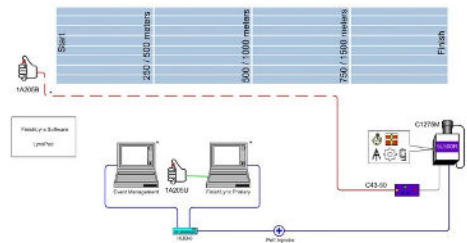

*Complete and wiring to suit (other not included in package)

© 1992 - 2007 Ligno Systems Development, Inc. Ligno Systems.com

Silver Level Rowing Package



Rowing - Canoe - Kayak – Silver

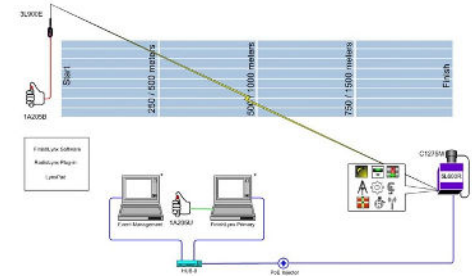

*Complete and wiring to suit (other not included in package)

© 1992 - 2007 Ligno Systems Development, Inc. Ligno Systems.com

Gold Level Rowing Package



Rowing - Canoe - Kayak – Gold

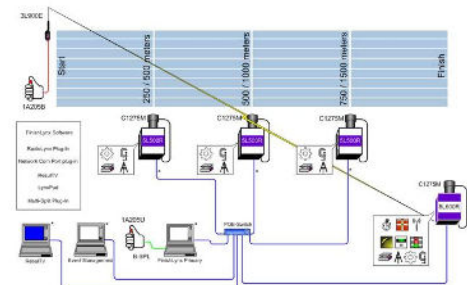

*Complete and wiring to suit (other not included in package)

© 1992 - 2007 Ligno Systems Development, Inc. Ligno Systems.com

Speed Skating Packages

Short Track Bronze Package

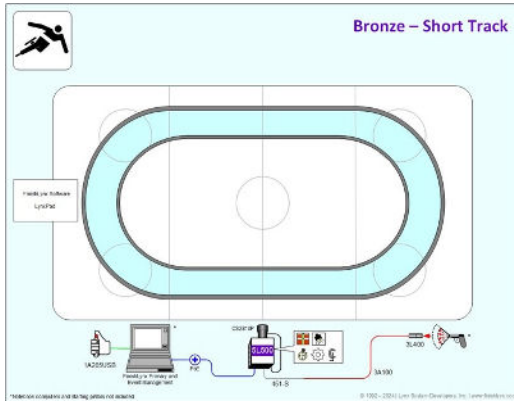

Short Track Silver Package

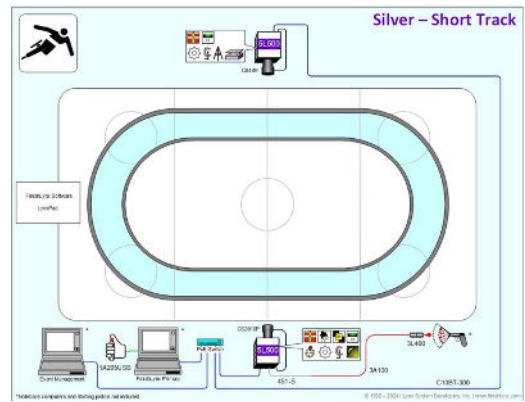

Short Track Gold Package

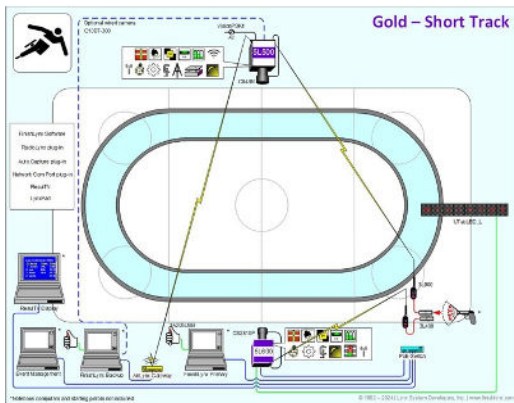

Short Track Manual Lap Timing Add On

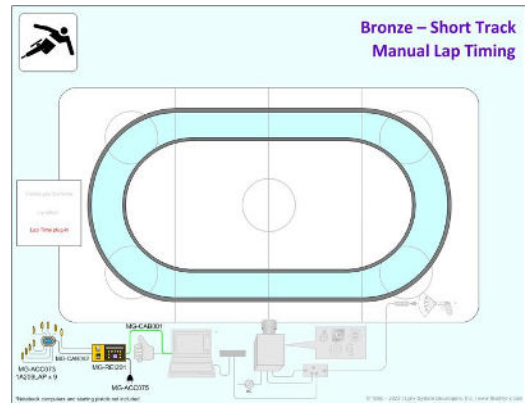

Short Track Transponder Lap Timing Add On

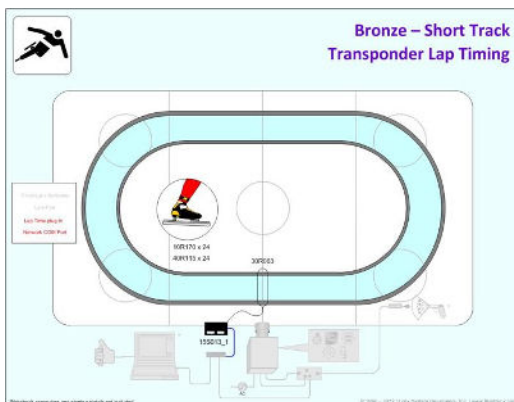

Long Track Bronze Package

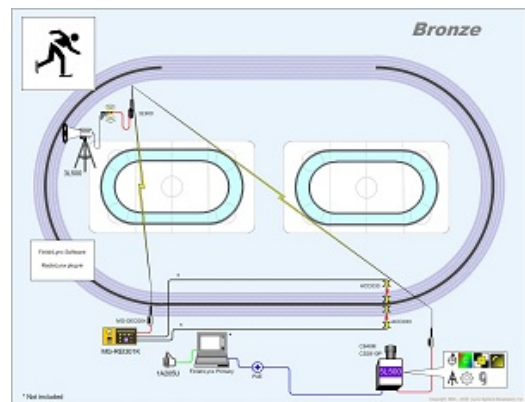

Open Water Swimming

Open Water Swimming - Base Package

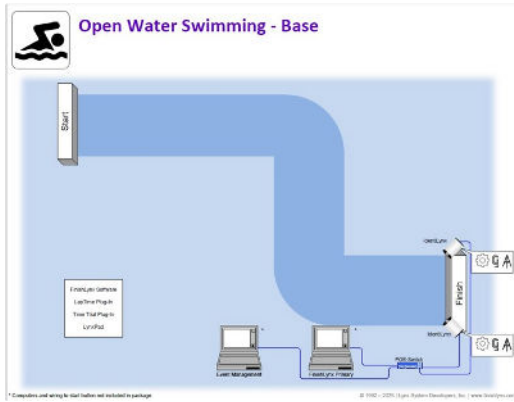

Open Water Swimming - LAP/T Package

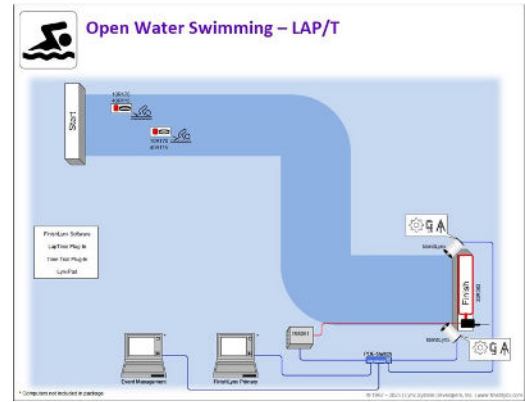

Index

Product	Code	Page
ProChip Timer Go (unit)	10R170	<u>46</u>
ThinTag	10S084	<u>46</u>
BibTag	10S085	<u>46</u>
6" 6-Digit LED Double Sided Display (90-264V)	12076XLC-RD	<u>60</u>
9" 6-Digit LED Double Sided Display (90-264V)	12079XLC-RD	<u>61</u>
12v Power Plug to Dual Sockets	12vPWRSplitter	<u>69</u>
Manual Zoom C-Mount Lens	155	<u>14</u>
Bibtag Portable Decoder 8M US	15S017_1	<u>46</u>
ProChip Decoder with Cabling	15S061	<u>46</u>
Large Carrying Case with Wheels	1A204L	<u>66</u>
Capture Button	1A205B	<u>6</u>
Capture Button & 5.9' Cord	1A205USB	<u>6</u>
Custom Camera Carrying Case	1A207	<u>66</u>
LinkPod Pushbutton	1A209LAP	<u>46</u>
Orbits Cycling software	25R030	<u>47</u>
Remote Positioner	2L102	<u>16</u>
Camera Mounting Post	2L200P	<u>18</u>
100m/330ft 75 Ohm coax with 2 BNC connectors	30R027AS	<u>47</u>
ProChip detection loop 6m (5m coax)	30R061	<u>47</u>
ProChip detection loop 9m (5m coax)	30R062	<u>47</u>
ProChip detection loop 12m (5m coax)	30R063	<u>47</u>
ProChip detection loop 16m (5m coax)	30R064	<u>47</u>
ProChip detection loop end box with loop wire of 6M/9M/12M	30R066	<u>48</u>
Set ProChip Detection Loops	30R069	<u>48</u>
ProChip Connection Box w/ 20m Coax	30R090	<u>48</u>
ProChip Detection Loop Box	30R091	<u>48</u>
ProChip Connection Box	30R094	<u>48</u>
ProChip Connection Box	30R095	<u>48</u>
ProChip Coax T-splitter	30R100	<u>49</u>
Prochip Mat	30R200	<u>49</u>
BibTag detection mat (rubber)	30S032	<u>49</u>
BibTag Side Antenna	30S038	<u>49</u>
EasyMat 4M	30S061	<u>49</u>
EasyMat Cart	30S062	<u>50</u>
EasyMat 6M	30S065	<u>49</u>
XLR-3 Start Cable - 500 foot	3A100	<u>33</u>
Facility Starting System	3A200	<u>33</u>
Normally Open Start Sensor	3L300	<u>24</u>
Normally Open Start Sensor for RadiiLynx	3L300R	<u>24</u>
Normally Closed Start Sensor w/ Ready Light	3L400	<u>24</u>
Electronic Start Speaker Kit	3L500SK	<u>23</u>
Electronic Starting System	3L500V2	<u>23</u>
Electronic Starting System Plus - Europe	3L501EU	<u>23</u>
Electronic Start System Plus - UK	3L501UK	<u>23</u>
Electronic Starting System Plus	3L501US	<u>23</u>
RadiiLynx Wireless Start System	3L900	<u>24</u>
Extended Range RadiiLynx Wireless Start System	3L900E	<u>24</u>
Nylon Mount	3L-Mount	<u>24</u>

Index

Product	Code	Page
Ankle strap ProChip FLEX	40R115	<u>50</u>
USB Transponder Tester	40R117AS	<u>50</u>
ProChip Communicator	40R121	<u>50</u>
Start button	40R316	<u>50</u>
Start button cable (BibTag+Prochip)	40R317	<u>50</u>
Start button cable (ProChip Portable Decoder)	40R323	<u>51</u>
Battery Cable with Car Plug	40S090	<u>51</u>
Battery Cable with Clamps	40S091	<u>51</u>
BibTag antenna tester	40S112	<u>51</u>
BibTag USB Reader	40S115	<u>51</u>
Raincover Bibtag	40S117	<u>51</u>
USB Modem ProChip Smart Decoder	40S122	<u>52</u>
Powercable with angled socket (EU)	40S213	<u>52</u>
Bibtag Cable Set 4m	40S214	<u>52</u>
Bibtag Cable Set 8m	40S215	<u>52</u>
Powercable with angled socket (US)	40S216	<u>52</u>
BibTag Coax 2m/red/nr1	40S409	<u>52</u>
BibTag Coax 3m/red/nr2	40S410	<u>53</u>
BibTag Coax 4m/red/nr3	40S411	<u>53</u>
BibTag Coax 5m/red/nr4	40S412	<u>53</u>
BibTag Coax 6m/red/nr5	40S413	<u>53</u>
BibTag Coax 7m/red/nr6	40S414	<u>53</u>
BibTag Coax 8m/red/nr7	40S415	<u>53</u>
BibTag Coax 9m/red/nr8	40S416	<u>54</u>
Bibtag Coax Side Antenna	40S420	<u>54</u>
25' US Power Cable	452	<u>36</u>
Complete 4M Easy Deployment	4M-EasyMat	<u>54</u>
Complete 4M Mat	4M-MA-BibSys	<u>54</u>
Complete Side Antenna RFID Timing for Track	4M-SA-BibSys	<u>54</u>
Complete RFID Split Timing for Track/XC	4MXCtrack	<u>54</u>
Notebook PC	4SX-25N	<u>67</u>
9" 5-Digit LED Display (90-264V)	5079XLC-RD	<u>61</u>
Frame Rate Upgrade from 3kfps to 10kfps	5L10K	<u>10</u>
VisionPro Upgrade fps: 3K to 20K	5L20K	<u>10</u>
Spare External Power Supply	5L300PS	<u>13</u>
Rain Guard	5L300RG	<u>13</u>
Frame Rate Upgrade from 3kfps to 5kfps	5L5K	<u>9</u>
Frame Rate Upgrade from 5kfps to 10kfps	5L5K10K	<u>10</u>
5L600 Vertical Res. Increase	5L600Zoom	<u>10</u>
VisionPro Upgrade fps: 6K to 20K	5L6K20K	<u>10</u>
Auto Capture Plug-In (ACM)	5LACM	<u>20</u>
Internal Camera Battery	5LBatt	<u>8</u>
Electronic Filter Option	5LEF	<u>7</u>
Electronic View Finder (EVF)	5LEVF	<u>7</u>
Internal GPS Synchronizer	5LGPS	<u>8</u>
High Resolution Option	5LHR	<u>7</u>
LapTime Plug-In	5LLAP	<u>20</u>
Internal Camera Level	5LLevel	<u>8</u>

Index

Product	Code	Page
LuxBoost™ Level 4	5LLUX4	<u>8</u>
LuxBoost™ Level 8	5LLUX8	<u>8</u>
External Synchronization Plug-In	5LPES	<u>20</u>
Lynx Data Port Plug-In	5LPLDP	<u>20</u>
RadioLynx Plug-In	5LPRL	<u>20</u>
Time Trial Plug-In	5LPTT	<u>21</u>
Multi-Split Plug-In	5LSPLIT	<u>20</u>
FinishLynx32 Software License	5LSW	<u>19</u>
Timer Enabling Option	5LTE	<u>9</u>
Video Display Option	5LVDM	<u>9</u>
Electronic View Finder Package	5LVision-EVF1	<u>7</u>
Wireless Option	5LWiFi	<u>9</u>
Wireless Option	5LWiFi2	<u>9</u>
Extended Resolution & Zoom	5LZOOM	<u>9</u>
6" 6-Digit LED Display (90-264V)	6076XLC-RD	<u>61</u>
9" 6-Digit LED Display (90-264V)	6079XLC-RD	<u>61</u>
Complete LaserLynx Pro III Package	6L209	<u>45</u>
ClerkLynx Site License	6LSW_CL	<u>43</u>
FieldLynx Site License	6LSW_FL	<u>43</u>
FieldLynx Scoreboard/Printer Interface Plug-In	6LSW1	<u>43</u>
FieldLynx Wind Gauge Software Plug-In	6LSW2	<u>43</u>
FieldLynx LaserLynx Plug-In Site License	6LSW3	<u>43</u>
Net Exchange Server license (w/ USB HW Key)	6LSW7U	<u>43</u>
FieldLynx Lite for Windows	6LSW8	<u>44</u>
Netbook	6LWinNet	<u>44</u>
Complete 6M Easy Deployment	6M-EasyMat	<u>55</u>
World Athletics Certified Starting Blocks	730155	<u>38</u>
XCscore Software	730156	<u>19</u>
Block Sensor	7L100	<u>38</u>
Spare ReactTime Internal Battery	7L100-B	<u>38</u>
ReactTime Training Case	7L100TC	<u>39</u>
Block Mounted Speaker	7L102	<u>39</u>
False Start Command Center	7L103	<u>39</u>
Block Sensor Clamp	7L105	<u>39</u>
Starter's Headset	7L106	<u>39</u>
ReactTime Line Printer	7L107	<u>39</u>
Block Sensor Cable (5.5meter)	7L108	<u>40</u>
Command Center Cable (30 meter)	7L108CC	<u>40</u>
Block Sensor Cable (13meter)	7L108L	<u>40</u>
One Lane Photo eye Kit	7L109	<u>40</u>
ReactTime Start Button	7L205	<u>40</u>
External Battery Pack for ReactTime Block Sensor	7LBATT	<u>40</u>
False Start Operating & Storage Unit	7LCART	<u>41</u>
ReactTime System Case	7LFSC	<u>41</u>
ReactTime Power Supply & Charger	7LPWR	<u>41</u>
Speaker Case	7LSC	<u>41</u>
ReactTime Serial Cable	7L-SERIAL	<u>38</u>
ReactTime Signal Input Cable	7L-SIGNAL	<u>38</u>

Index

Product	Code	Page
ReactTime Input Splitter	7L-SPLITTER	<u>38</u>
ReactTime Championship Software License	7LSWFS	<u>41</u>
ReactTime Training Software License	7LSWTR	<u>41</u>
Mini Tripod	7LTP	<u>28</u>
AirLynx Gateway	8L101	<u>69</u>
AirLynx Amplified Antenna Kit	8L105	<u>69</u>
Directional Antenna	8L107	<u>69</u>
SerialLynx (Wired/Wireless)	8L110	<u>69</u>
SerialLynx (Wired/Wireless) w/ External Batt. Pack	8L110-B	<u>69</u>
Belt Clip Kit for RadioLynx Transmitter	8L-Clip	<u>25</u>
Power Supply	8L-PS-12V	<u>25</u>
Complete 8M Mat RFID Timing	8M-MA-BibSys	<u>55</u>
LynxPad Meet Management Software	9LSW01	<u>19</u>
Wireless Photocell Kit	ACC033K	<u>28</u>
Wireless Photocell Kit - Short Range	ACC093K	<u>28</u>
Spare antenna for Internal RadioLynx Receiver	ANT-433MR	<u>25</u>
Heavy Duty Crank-Up Camera Stand	B200	<u>17</u>
Reversible Stud for Super Head Clamp	BG2907	<u>17</u>
Super Head Clamp	BG2909	<u>16</u>
Ground Level Photocell Tripod	BG-3007K2	<u>28</u>
Heavy Duty Tripod w/ Leveling Guide	BG3036	<u>17</u>
Swivel Tilt Head	BG3232	<u>16</u>
Heavy-Duty Geared Mounting Head	BG3263	<u>16</u>
Quick Release Plate	BG3271	<u>16</u>
Geared Mounting Head	BG3275	<u>16</u>
Micro Positioning Plate	BG3419	<u>17</u>
Medium Duty tripod	BG394	<u>17</u>
Bronze Level BMX Cycling Package	BMX--Bronze	<u>76</u>
Gold Level BMX Cycling Package	BMX--Gold	<u>76</u>
Silver Level BMX Cycling Package	BMX--Silver	<u>76</u>
Network Cable - 100'	C10BT-100	<u>35</u>
Network Cable - 200'	C10BT-200	<u>35</u>
Network Cable - 25'	C10BT-25	<u>35</u>
Network Cable - 300'	C10BT-300	<u>35</u>
Remote Controlled Zoom C-Mount Lens	C1275M	<u>14</u>
XLR-3 Start Cable - 10 foot	C43-10	<u>33</u>
XLR-3 Start Cable - 100 foot	C43-100	<u>33</u>
XLR-3 Start Cable - 200 foot	C43-200	<u>34</u>
XLR-3 Start Cable - 25 foot	C43-25	<u>33</u>
XLR-3 Start Cable - 300 foot	C43-300	<u>34</u>
XLR-3 Start Cable - 50 foot	C43-50	<u>33</u>
C-Mount 8-48mm Manual Lens	C848	<u>14</u>
C-Mount 8-48mm Motorized Zoom Lens	C848M	<u>14</u>
Connection Box	C-Box2	<u>6</u>
Athletics (Track) - Championship Elite	Championship-Elite-Vision	<u>72</u>
Athletics (Track) - Championship	Championship-Vision	<u>72</u>
Cable for WG-Lynx to External Battery	C-LynxWG-Batt	<u>31</u>
WG-Lynx Input cable	C-LynxWG-Input	<u>31</u>

Index

Product	Code	Page
Athletics (Track) - Competition Elite	Competition-Elite-Vision	<u>72</u>
Athletics (Track) - Competition	Competition-Vision	<u>72</u>
Heavy Duty Custom Carrying Case – Small	CP102	<u>66</u>
CS-Mount 2.8-10mm P-Iris	CS2810P	<u>14</u>
Angled Field Display Mount, 60" Wide	DisplayMount	<u>61</u>
Angled Field Display Mount, 36" Wide	DisplayMount-36	<u>61</u>
4-Digit LED Display & Countdown Timer	E39820	<u>32</u>
25' European Power Cable	Euro-Power	<u>36</u>
Euro Power Cord	EuroPwr25-WR-75M	<u>36</u>
Ext. Wireless	Ext_WiFi	<u>6</u>
Ext. Wireless	Ext_WiFi2	<u>6</u>
Includes 7LBatt & C-LynxWG-Batt	EXTBatt_WGLX	<u>32</u>
Athletics (Field) - Championship	Field-Championship	<u>73</u>
Athletics (Field) - Championship Elite	Field-Championship-Elite	<u>73</u>
Athletics (Field) - Competition	Field-Competition	<u>73</u>
Athletics (Field) - Competition Elite	Field-Competition-Elite	<u>73</u>
Athletics (Field) - Grand Prix	Field-Grand-Prix	<u>73</u>
Athletics (Field) - Grand Prix Elite	Field-Grand-Prix-Elite	<u>73</u>
Wheel Assembly Kit	Fld_D1S_WA	<u>60</u>
Infield Display & Frame - 2-Sided	Fld_Dsply_2S	<u>59</u>
Infield Display & Frame - 3-Sided	Fld_Dsply_3S	<u>60</u>
Wheel Assembly - 3-Sided Infield Displays	Fld_Dsply_WA	<u>60</u>
Wheel Assembly - 2-Sided Display	Fld_Dsply_WA_2	<u>60</u>
Infield Display & Frame - 1 Sided	fld-dsply_1S	<u>59</u>
Universal Display Foot Set	FLT-LXLEDFeet	<u>60</u>
Athletics (Track) - Grand Prix Elite	Grand-Prix-Elite-Vision	<u>72</u>
Athletics (Track) - Grand Prix	Grand-Prix-Vision	<u>72</u>
IdentiLynx HRS Package	HRS-IdentiLynx	<u>74</u>
Spare Headset for Electronic Starting System	HS-9	<u>25</u>
IdentiLynx SR-2 Video Camera	IDL SR-2	<u>11</u>
CS Mount Lens	IDL-CS8.5-50f1.6	<u>11</u>
IdentiLynx HRS Video Camera	IDL-HRS	<u>11</u>
Power-over-Ethernet	IDL-PoE	<u>11</u>
Premium Quality Ink Jet Printer	INKJET	<u>67</u>
Internal RadioLynx Start System	Int-3L900	<u>25</u>
Ext. Range Internal RadioLynx Start System	Int-3L900E	<u>25</u>
Internal RadioLynx Receiver	INT-DEC-004	<u>7</u>
Lynx Portable Display Kit	KPort_Dsply	<u>59</u>
2-Digit Single-Sided Lap Counter 15m	LAP2-15-1	<u>62</u>
Laser Printer 1200 DPI	Laser-600	<u>67</u>
2-Digit Single-Sided Lap Counter	LCB2-25-1	<u>62</u>
2-Digit Three-Sided Lap Counter 25cm with Tripod	LCB2-25-3	<u>62</u>
3-Digit Three-Sided Lap Counter 25cm with Tripod	LCB3-25-3	<u>62</u>
Long Track Bronze Package	LT-Bronze	<u>78</u>
Long Track Gold Package	LT-Gold	<u>79</u>
Long Track Transponder Lap Timing Add On	LT-LAPT	<u>79</u>
Long Track Silver Package	LT-Silver	<u>79</u>
LuxBoost™ Upgrade	LuxUpgrade8	<u>8</u>

Index

Product	Code	Page
Lynx Single Level Round Display	Lynx360_Dsply1	<u>59</u>
Lynx Double Level Round Display	Lynx360_Dsply2	<u>59</u>
CS-Mount to C-Mount Adapter	MCS-C	<u>14</u>
Start Gate w/ Double Contact (FIS) and Bar	MG-ACC032	<u>26</u>
Long Range, Single Beam Photocell	MG-ACC033	<u>28</u>
Reflector for Long Range, Single Beam Photocell	MG-ACC034	<u>28</u>
Banana Cube Adapter	MG-ACC054	<u>29</u>
Paper Roll for REI2 and REI Pro	MG-ACC067	<u>55</u>
LinkPod with 8 Inputs	MG-ACC073	<u>55</u>
Battery Charger for REI2	MG-ACC075	<u>55</u>
Support for Double Photocell/Reflector	MG-ACC083	<u>29</u>
Short Range, Single Beam Wireless Photocell	MG-ACC089	<u>42</u>
Short Range, Single Beam Photocell	MG-ACC093	<u>29</u>
Double Photocell Kit (15m Range)	MG-ACC093D	<u>29</u>
Single Photocell Kit (15m Range)	MG-ACC093S	<u>29</u>
Reflector for Short Range, Single Beam Photocell	MG-ACC094	<u>29</u>
3 Button Keypad with 10m Cord	MG-ACC107	<u>55</u>
Photocell holder	MG-ACC123	<u>30</u>
Microtab LED 48V Power Supply	MG-ACC147	<u>62</u>
Micrograph LED 48V Power Supply	MG-ACC161	<u>62</u>
Wi-Fi Option: Microtab/Micrograph LED Displays	MG-ACC164	<u>63</u>
2 Button Keypad	MG-ACC167	<u>63</u>
Amplified LinkPod with 8 Inputs	MG-ACC173	<u>56</u>
REI Pro - Active GPS Antenna	MG-ACC258	<u>56</u>
Battery Charger for REI Pro	MG-ACC275	<u>56</u>
Micrograph LED Carry Bag	MG-BAG035	<u>63</u>
Microtab LED Carry Bag	MG-BAG036	<u>63</u>
Bag for 3-Sided Lap Counter	MG-BAG038	<u>63</u>
Transport Case	MG-BAG055	<u>56</u>
60' Cable Display Board to PC	MG-CAB010	<u>63</u>
Cable REI2-LinkPod, 20 meter	MG-CAB086	<u>56</u>
Cable REI2-LinkPod, 5 meter	MG-CAB092	<u>56</u>
Cable LinkPod-LinkPod, 2.6m	MG-CAB094	<u>57</u>
Cable for Double Photocell	MG-CAB119	<u>30</u>
Power Cable	MG-CAB156	<u>64</u>
RadioLynx Receiver	MG-DEC004	<u>26</u>
RadioLynx Receiver Serial Cable	MG-DEC004-Serial	<u>26</u>
Receiver: Short Range, Single Beam Photocell	MG-DEC005	<u>42</u>
Spare antenna for RadioLynx	MG-ELA009	<u>26</u>
RadioLynx Transmitter	MG-ENC004	<u>26</u>
RadioLynx Transmitter and Power Supply	MG-ENC004R	<u>26</u>
Extended Range RadioLynx Transmitter	MG-ENC204	<u>27</u>
REI PRO Programmable Chronometer	MG-REI301	<u>57</u>
REI PRO Chronometer Kit	MG-REI301K	<u>57</u>
External Synchronization Kit	MG-SYN001_K	<u>58</u>
Microtab LED Display	MG-TAL002	<u>64</u>
Micrograph LED Display	MG-TAL003	<u>64</u>
Microtab 3 Face LED Lap Counter Display	MG-TAL004	<u>64</u>

Index

Product	Code	Page
uCom Headset Amplifier	MG-TEL003	<u>42</u>
Spare Prism Kit	MPU1	<u>45</u>
F-Mount Adapter	MV-R	<u>15</u>
F-mount Adapter	MV-RF	<u>15</u>
Uninterruptible Power Supply	OMNI-675	<u>67</u>
Open Water Swimming - Base Package	OWS Base	<u>80</u>
Open Water Swimming - LAP/T Package	OWS LAP/T	<u>80</u>
Spare Prism Pole	PC21	<u>45</u>
Photocell Input Cable - 15 feet long	PE-Input	<u>30</u>
8-Port 10/100 Power over Ethernet Switch	PoE-Switch	<u>70</u>
Lynx Portable Display	Port_Dsply	<u>59</u>
Travel/Shipping Case for Lynx Portable Display	Port_Dsply_CS	<u>66</u>
Portable-VDM	PortVDM	<u>22</u>
Spare Gun for Electronic Starting System	PS-78X	<u>23</u>
ResultV Software (Broadcast Version)	ResultV-BR	<u>22</u>
ResultV (Broadcast Version) Upgrade	ResultV-BR_Upgrade	<u>22</u>
ResultV Software License with USB HW key	ResultV-U	<u>22</u>
ResultV-VDM Software License	ResultV-VDM	<u>22</u>
Bronze Level Road Cycling Package	Road-Cycling-Bronze	<u>76</u>
Gold Level Road Cycling Package	Road-Cycling-Gold	<u>76</u>
Silver Level Road Cycling Package	Road-Cycling-Silver	<u>76</u>
Bronze Level Rowing Package	Rowing--Bronze	<u>77</u>
Gold Level Rowing Package	Rowing--Gold	<u>77</u>
Silver Level Rowing Package	Rowing--Silver	<u>77</u>
Additional ReactTime wired lane	RT1	<u>75</u>
Complete 6 lane ReactTime False Start System - Wired	RT6L	<u>75</u>
Complete 8 lane ReactTime False Start System - Wired	RT8L	<u>75</u>
ReactTime Training System - Starter System	RT-T	<u>75</u>
ReactTime Training System – Advanced	RT-TA	<u>75</u>
ReactTime Training System - Advanced Wired	RT-TAP	<u>75</u>
Spare Data Cable	S50660	<u>45</u>
Spare Battery	S62005	<u>45</u>
Heavy Duty Custom Carrying Case – Medium	SE520	<u>66</u>
F-Mount 50-100mm f/1.8 Lens	SI5010018DCN	<u>15</u>
Identilynx SR Package	SR-Identilynx	<u>74</u>
Paper roll for ReactTime DPU414 Printer	SS112-25A	<u>42</u>
Short Track Bronze Package	ST-Bronze	<u>78</u>
Short Track Gold Package	ST-Gold	<u>78</u>
Short Track Manual Lap Timing Add On	ST-LAPM	<u>78</u>
Short Track Transponder Lap Timing Add On	ST-LAPT	<u>78</u>
Short Track Silver Package	ST-Silver	<u>78</u>
10" 7-Digit LED Display for Field Events	TI-2021	<u>64</u>
Heavy Duty Tripod with Leveling Guide	TP-105	<u>17</u>
Camera Diagnostics	TR10	<u>37</u>
Display Tripod Stand	TS02	<u>64</u>
Spare Aluminum Tripod	TS50F	<u>45</u>
Uninterruptible Power Supply	UPS-200	<u>67</u>
USB to Serial Converter 1 Port	USB-Serial1	<u>67</u>

Index

Product	Code	Page
USB to Serial Converter-2 Port	USB-Serial2	<u>68</u>
25' US Power Cord	USPwr25-WR	<u>36</u>
Microtab LED Kit	UTabLED	<u>65</u>
Microtab LED 3-Sided Lap Counter Display Kit	UtabLED_3S	<u>65</u>
VeriLynx Package - Bronze	VeriLynx-Bronze	<u>74</u>
VeriLynx Package - Gold	VeriLynx-Gold	<u>74</u>
VeriLynx Package - Silver	VeriLynx-Silver	<u>74</u>
VeriLynx V30 Camera	VER-V30	<u>11</u>
VeriLynx V60 Camera	VER-V60	<u>11</u>
Plexiglass Cover	Vision-CVR	<u>7</u>
Vision Series AC/DC and DC in Power Supply Kit	VisionPSKit	<u>6</u>
VeriLight	VLight-A	<u>65</u>
Weather Proof Wind Gauge	WG-Lynx	<u>31</u>
Includes WG-Lynx, 7LBATT & C-LynxWG-Batt	WG-Lynx-B	<u>31</u>
Weather Proof Wind Gauge	WG-Lynx-SA	<u>31</u>
Includes WG-Lynx-SA, 7LBATT & C-LynxWG-Batt	WG-Lynx-SA-B	<u>31</u>
Standalone Controller	WG-SA-CTRL	<u>32</u>
100' CAT6 w/ RJ45	WPCAT6-100	<u>12</u>
Weatherproof hood for RJ45 connector	WPCN-RJ45	<u>12</u>
1 Year Extended Product Warranty	XTWRNT_1Y	<u>37</u>
2 Year Extended Product Warranty	XTWRNT_2Y	<u>37</u>
3 Year Extended Product Warranty	XTWRNT_3Y	<u>37</u>

Important Notice

Use of Lynx Software Products are governed by the Sales and License Agreement signed by you or your agent (the "Buyer"), Section 7a of which is reprinted below:

7a. Ownership of Software. Lynx System Developers, Inc. (Lynx) owns and retains all title, copyright, trademark, and other proprietary rights in the software, firmware and documentation provided with the software and firmware (collectively, "Software"). Buyer acknowledges that the Software is the confidential property of Lynx and the Buyer will not disclose the Software to any other person without Lynx's consent.

FinishLynx, EtherLynx, CyberScoreboard, ReacTime, and the FinishLynx logo are registered trademarks of Lynx System Developers, Inc.

SerialLynx, FieldLynx, LaserLynx, InterLynx, ClerkLynx, Exchange, ResultTV, LynxTV, VCPD and AirLynx are trademarks of Lynx System Developers, Inc.

Windows is registered trademark of Microsoft Corp.

Photoshop and PostScript are registered trademarks of Adobe Systems Incorporated.

Palm™ OS, Palm™ Computing, Graffiti, HotSync, are registered trademarks of Palm, Inc. Palm, the Palm logo, the HotSync® logo are trademarks of Palm, Inc.

All other trademarks are properties of their respective companies.

The following statement applies to the Independent JPG Group's software which is included with FinishLynx 32. The authors make NO WARRANTY or representation, either express or implied, with respect to this software, its quality, accuracy, merchantability, or fitness for a particular purpose. This software is provided "AS IS", and you, its user, assume the entire risk as to its quality and accuracy. This software is copyright (C) 1991-1996, Thomas G. Lane. All Rights Reserved except as specified below. Permission is hereby granted to use, copy, modify, and distribute this software (or portions thereof) for any purpose, without fee, subject to these conditions: (1) If any part of the source code for this software is distributed, then this README file must be included, with this copyright and no-warranty notice unaltered; and any additions, deletions, or changes to the original files must be clearly indicated in accompanying documentation. (2) If only executable code is distributed, then the accompanying documentation must state that "this software is based in part on the work of the Independent JPG Group". (3) Permission for use of this software is granted only if the user accepts full responsibility for any undesirable consequences; the authors accept NO LIABILITY for damages of any kind. These conditions apply to any software derived from or based on the IJG code, not just to the unmodified library. If you use our work, you ought to acknowledge us. Permission is NOT granted for the use of any IJG author's name or company name in advertising or publicity relating to this software or products derived from it. This software may be referred to only as "the Independent JPG Group's software". We specifically permit and encourage the use of this software as the basis of commercial products, provided that all warranty or liability claims are assumed by the product vendor.

Lynx Catalog

Copyright © 6/3/2024 by Lynx System Developers, Inc.

All rights reserved.

End of Document