

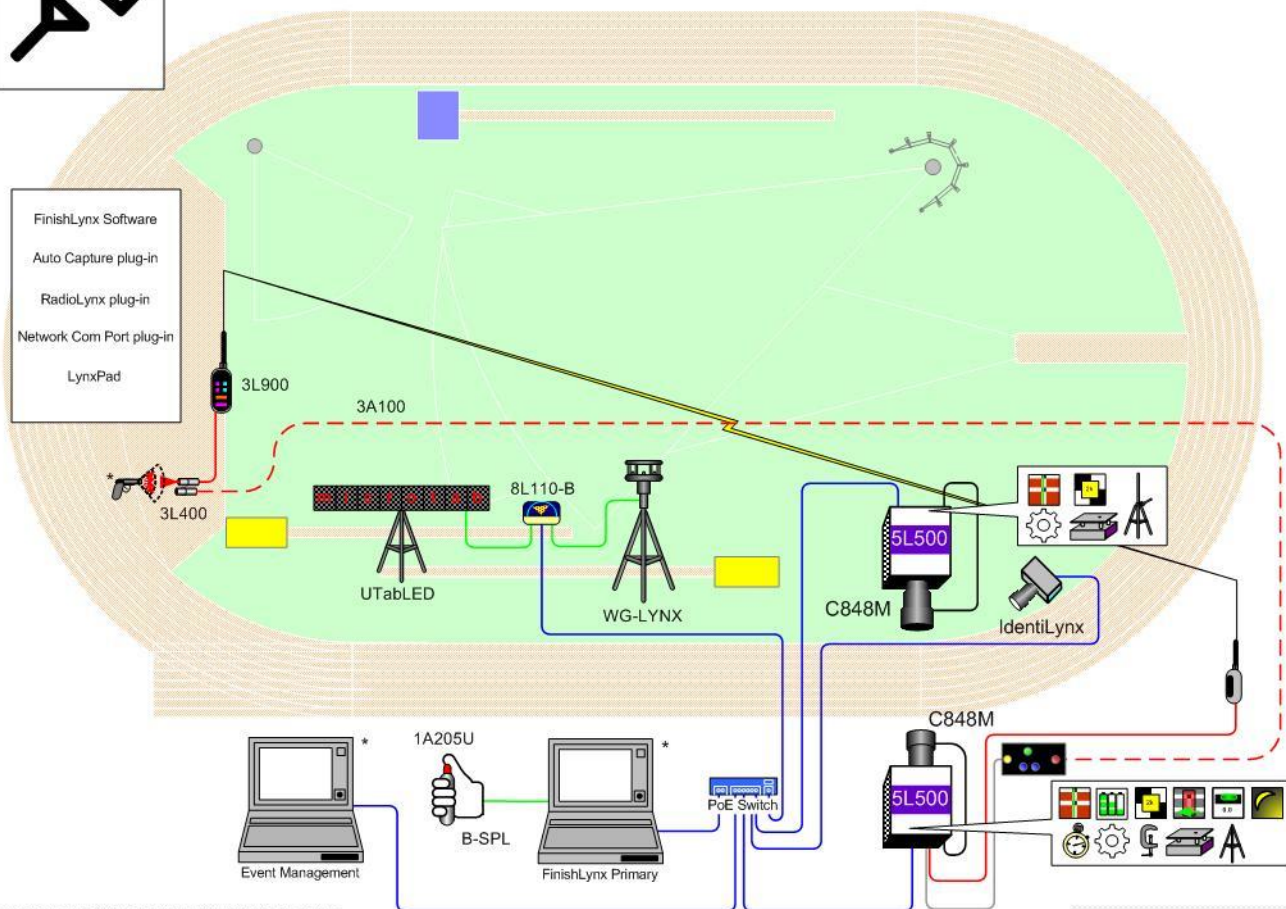

# FINISHLYNX CHAMPIONSHIP ELITE PACKAGE QUICK START GUIDE

FOR ETHERLYNX VISION CAMERAS

## *Championship Elite*





























\* Computers and starting pistol not included in package

Copyright 2015 Lynx System Developers, Inc.

Updated March 2016

## Quick-Start Guide - FinishLynx Championship Elite Package Timing System

Please verify that your FinishLynx Championship Elite System contains all the components pictured here. If something is missing, or if you have questions setting up your system after following this quick start guide, call: 1-800-989-LYNX. For additional tech support documents and downloads, visit [www.finishlynx.com/support/](http://www.finishlynx.com/support/)

Item	Description	Part #	Item	Description	Part #
	Carrying Case (x2)	1A207		Normally closed start sensor with light	3L400
	EtherLynx Vision high sensitivity camera (x2)	5L500		500 ft. start sensor cable	3A100
Not pictured	Timer-Enabled option for 5L500 camera	5LTE		Connection box	C-Box
Not pictured	High Resolution option for 5L500 camera	5LHR		Connection box cable	451
	C-Mount 8-48mm f1.2 Motorized Zoom Lens (x2)	C848M		25 ft. Ethernet cable (x4)	C10BT-25
	CS Mount 2.8-10mm P-Iris lens (x2)	CS2810P		100 ft. Ethernet cable (x2)	C10BT-100
	CS Mount to C Mount Adapter	MCS-C		Capture button and USB/Serial adapter	1A205
	Remote positioner (x2)	2L102		Button splitter	B-SPL
	Geared head (x2)	BG3275		MicroTab scoreboard, carrying case and charger	MG-TAB9
	Super head clamp (x2)	BG2909		RadioLynx Transmitter and Receiver - with RadioLynx start sensor (red casing)	3L900
	Camera tripod	BG3036		Laminator kit with 50 foam boards	Laminator
	Identilynx Full Frame Video Camera kit	Identilynx		Sonic Wind Gauge with Tripod and 50m cable	WG-Lynx
	8 port 10/100 Power over Ethernet switch	PoE-Switch		SerialLynx and Battery Pack	8L110-b
	Heavy Duty, Crank-Up Tripod with wheels.	B200		Lynx USB Flash Drive with FinishLynx, LynxPad, & ACM/NCP/RL Plugins	5LSW and 9LSW01
<p><b>Be sure to keep your USB flash drive safe. It includes your Serial Numbers, Software, &amp; Quick-Start Guides. To access the files, insert the flash drive in your computer and click on <a href="#">START.html</a></b></p>					

### Items not included

- **Laptop or netbook** computer running Microsoft Windows. Your computer needs: 1 available serial port (or USB port with serial adapter) and 1 available Ethernet port. A **printer** is also optional.

## Introduction

In this QSG, you will learn how to configure the FinishLynx network, set up the dual-angle EtherLynx Vision cameras and align them with the finish line using the remote control features. You will also learn how to capture, evaluate, and print a FinishLynx results image, configure FinishLynx to work with the scoreboard, and import a start list created in LynxPad.

### Step 1: Go to the track

Bring your FinishLynx system (and an assistant) to the track. Make sure there is **power** available for your computers and for the Power over Ethernet switch. The EtherLynx Vision camera and the IdentiLynx camera will receive their power via the Ethernet data cables.

Set up a table near the finish line, ideally on the infield if power is available. The finish line should have black lane markers painted or taped on the finish. If not, we suggest you use black matte tape to designate lane lines. This will help you align the camera and get clearer images.

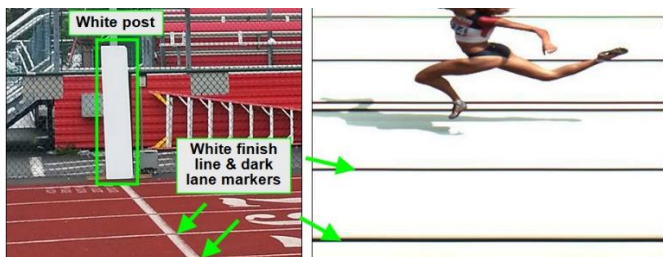

### Step 2: Install the software

#### A. FinishLynx Software & Plugins

Insert the Lynx USB flash drive in your computer and click on [START.html](#) to access the software installers and serial numbers. You can also download the latest version of FinishLynx on our website: [www.finishlynx.com/product/software/finishlynx-results-software/](http://www.finishlynx.com/product/software/finishlynx-results-software/)

Install FinishLynx, the RadioLynx Plugin, ACM Plugin, and NCP Plugin from the flash drive. When prompted, enter the serial numbers found inside the flash drive.

- 1) Start FinishLynx by clicking the Windows **Start** button and selecting **All Programs | FinishLynx**.
- 2) Verify that you have correctly installed the RL, ACM, and NCP Plugins by clicking **Help** from the Menu bar and selecting **About....** When the **About FinishLynx** dialog appears, the RL, ACM and NCP Plugins are listed with the serial numbers you entered during installation.

#### B. LynxPad

Install using the Lynx USB Flash Drive or download the latest version of LynxPad at: [www.finishlynx.com/product/event-management/lynxpad/](http://www.finishlynx.com/product/event-management/lynxpad/)

Follow the instructions on your screen to install LynxPad. When prompted, enter the serial number found on the flash drive.

**Note:** You should **Right Click** on the installer and select **Run as Administrator** to install LynxPad, if you do not, you will not be able to print from LynxPad.

### Step 3: Evaluate a sample image

1. Start FinishLynx. Click **File - Open...**
2. Double-click **Sprint.evn** to open the sample event.

**Note:** This sample is a two-camera image. Your Championship Elite System uses only 1 line-scan camera and produces single-camera images.

3. Click the mouse once on the torso of a competitor on the left side of the screen. A red hairline appears. Enter the lane number for the athlete in the identification box.
4. Press the **Enter** key on your computer. The finisher's time appears in the start list above the image.
5. Repeat these steps for all of the competitors on the screen. You have just successfully evaluated a race in FinishLynx.
6. Click **File | Close window**. If you want to reuse the image later for practice evaluation, click **No** when asked to save your changes. Close FinishLynx.

### Step 4: Configure the network for Windows OS prior to Windows 7 (See Step 5: below for Windows 7,8 and higher)

1. Click the Microsoft Windows **Start** button and select **Control Panel**, or click **Start | Settings | Control Panel**.
2. Double-click **Network Connections**.
3. Right-click the **Local Area Connection** associated with the network interface card (NIC) in use and select **Properties**. The **Local Area Connection Properties** dialog appears.
4. Make sure you see a line that reads, **Internet Protocol (TCP/IP)**. You may have to scroll down to see it.
  - a. Click **Install** and select **Protocol**.
  - b. Click **Add....**
  - c. Click to select the **Microsoft TCP/IP** option and then click **OK**.
5. Check the box next to **Internet Protocol (TCP/IP)**.
6. Click to select **Internet Protocol (TCP/IP)** and then click **Properties**. The **Internet Protocol (TCP/IP) Properties** dialog appears.
7. Click the **Use the following IP Address:** button and then type the following numbers:
  - IP address: **192.168.0.5**
  - Subnet mask: **255.255.255.0**. Click **Ok** and then click **Ok** again.
8. **If you are running Windows XP, follow these steps to disable the firewall. Otherwise continue to Step 6:**
  - a. Open the Windows **Network & Sharing Center**.

- b. Right-click the **Local Area Connection** associated with your system, and select **Properties**. The Local Area Connection dialog appears.
- c. Click the **Advanced** tab.
- d. Make sure the box **under Internet Connection Firewall** is *unchecked*.
- e. Click **Ok** and then exit the Network Connections screen. **Restart your computer**.

### Step 5: Configure the network for Windows 7 & 8 (if applicable)

**Note: Sections 1 and 2 should be completed on both FinishLynx and Meet Management computer.**

1. Go to the Windows **Control Panel**. On the top right is **View By** with a drop down arrow. Click the drop down arrow and choose Small or Large Icons.
2. Find and double click on **Network and Sharing Center**. They are listed alphabetically by icon name.
3. This will open the **Network and Sharing Center**. On the left is a blue section titled Control Panel Home.
4. Click on the **Change Adapter Settings** icon.
5. A new window will open displaying your network connections. Right click on the **Wireless Network Connection** and select **Disable** from the list of items. This is only necessary for the FinishLynx Capture computer.
6. Right click on the **Local Area Connection** and select **Properties** from the list of items. A new window will appear with a list of connection items. Click to select **Internet Protocol Version 4 (TCP/IPv4)** and click the **Properties** button.
7. A Properties window will appear and is typically set to **Obtain an IP address automatically**. Click to select the radio button for **Use the following IP address**. In the box for IP address, enter 192.168.0.5 for FinishLynx and hit **Tab** key to auto fill in Subnet mask 255.255.255.0
8. Click OK and navigate back to the Control Panel. In the control panel click on the Windows Firewall icon. Under Control Panel Home, on the left, click on **Turn Windows Firewall on or off**.
9. Turn off both Home and Public Firewalls (Domain for Windows Pro).

### Step 6: Set up the Primary camera and tripod

Setup the tripod in line with the finish line, preferably on the infield and approximately **10 feet back**. **Note:** Minimum recommended camera distance from track is 8 feet (at this distance you may not be able to see the feet of the athlete in Lane 1 – being able to see the feet is not a requirement for accurate timing on the Torso of the athlete). If you need to be closer than this you may have to use the optional 6mm lens supplied with your Championship Elite package.

1. Extend the tripod legs so the geared head is approximately 7 ft high.
2. On the near side of the finish line, hold a plumb bob so that it is suspended directly above the middle of the finish line. This is the **plumb line**, shown as **a** in the image below.
3. Tie string to the screw on the top of the tripod head. Have your assistant take the other end of the string to the far side of the finish line and hold the string taut. This is the **sight line**, shown as **b** in the image below.
4. Move the tripod to the left or right until the plumb line and sight line touch at position **C** in the image below. The tripod is now in the plane of the finish line.

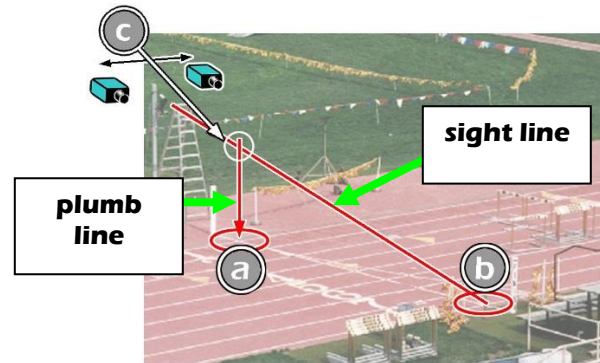

### Step 7: Attach the camera to the tripod

1. Secure the remote positioner to the camera bottom by turning the black handled thumbscrew. Make sure the FinishLynx label faces in the same direction as the camera lens will face.



**Note:** Cables omitted for clarity and actual lens may vary from model shown

2. Connect the cable that comes with the remote positioner to the port on the positioner and the port on the back of the camera labeled **Remote**.
3. Connect the cable on the remote lens to the remaining serial port on the remote positioner.
4. Secure the geared head to the top of the tripod.
5. Note how the mounting plate is attached to the top of the geared head. Then, pull back on the lever at the top of the geared head to release the mounting plate.
6. Tighten the mounting plate to the bottom of the remote positioner by turning the screw with a flathead screwdriver. Make sure the **Lens** marking on the bottom of the plate is facing the front of the remote positioner (where the Lynx label is affixed).

- Attach the camera with the remote positioner and mounting plate to the tripod by clicking the mounting plate into place on the geared head.
- With the camera lens lined up with and facing the finish line, make minor adjustments to the tripod legs so both bubbles on the tripod are centered.
- Turn the black knob on the geared head that controls the **tilt** of the camera so that it is at about a 30 degree angle to the ground.

## Step 8: Connect the cables

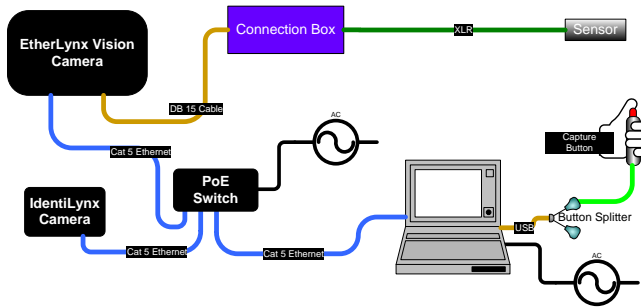

- Connect the female end of connection box cable to the port on the back of the camera labeled **Connection Box** and the male end to the left side of the connection box.

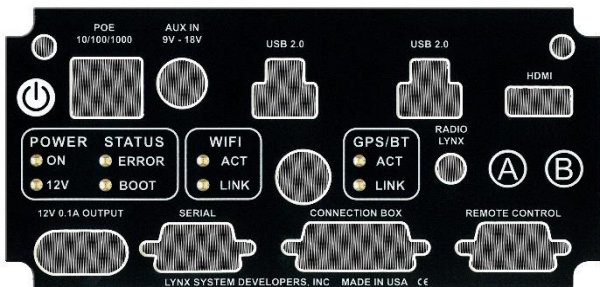

- Connect an Ethernet cable between the back of the camera labeled **POE 10/100/1000** and a port on the Power over Ethernet switch.
- Connect an Ethernet cable to the network connection on your computer and the other end to a port on the Power over Ethernet switch.
- Connect the male end of the start sensor cable to the connection box where it says **Start**. Attach the start sensor to the other end of the cable and keep the start sensor close by.
- Connect the button splitter to a 9-pin serial port, or a USB port with the supplied adaptor, on your computer.
- Connect the capture button cable to the 9-pin serial port on the button splitter that is labeled **Capture Button**.
- Depending on the distance between the scoreboard and your computer or camera, connect the scoreboard serial cable, either to the **Serial Port** on your Connection box, or to the other 9-pin serial port on the button splitter.
- Turn on the camera by pressing and holding the power button on the back plate.

## Step 9: Align the Primary camera

**Note:** The EtherLynx Vision camera can be aligned using either 1-D mode or 2-D EasyAlign mode. We recommend using EasyAlign. If you are using an older model EtherLynx camera, however, it must be aligned using classic 1-D mode.

**NOTE** If running a wireless Ethernet card on your computer, we recommend that you disable it while the camera is booting.

**Start FinishLynx.** Wait while the green status bar in the lower right corner of the screen completes its cycle.

### Align Vision Camera in EasyAlign 2-D Video Mode

- Activate EasyAlign** by clicking on the 2D align Icon  in the top left hand corner of the FinishLynx **Hardware Control** screen.

The icon turns green  and the 2-D video viewer appears within the software. The 2-D viewer makes it easy to see how your camera is aligned on the finish. **The goal is to align the green vertical line with the painted finish line and near its front edge.**

- Adjust Remote Lens/Positioner Controls** - Adjust the remote lens/position controls on the right of the FinishLynx hardware control screen.

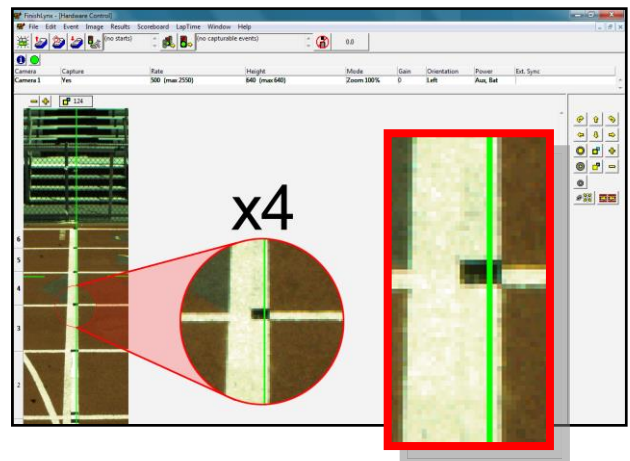

### Center Remote Camera Positioner

Click  to center the camera automatically using the remote positioner.

### Remote Camera Tilt, Pan & Swivel

Use the remote **Tilt**, **Pan**, and **Swivel** buttons to adjust the orientation of the camera on the finish. You want to ensure that the green vertical line is perfectly aligned on the white finish line and that all lanes are visible in the viewer.

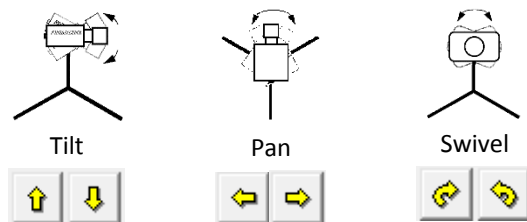

Have your assistant run through the finish line and watch where he/she appears on the computer monitor. The goal is for the runner's torso to be fully visible in both the inside and outside lanes. Once the camera's position is correct, you can then optimize the remote lens settings.



### Remote Iris (adjusts amount of light in lens)

Open or Close the remote iris to bring the ACM value as close to 1 as you can by clicking and holding the remote Iris buttons.

### Remote Focus (adjusts near/far image focus)

Click and hold the  buttons on the keypad on the right of the FinishLynx screen until the image becomes crisp. Start by focusing on the far lane and adjust until all lanes are in focus. Ensure that athletes in all lanes (near and far) are in focus.

**Note:** If you are having a hard time getting crisp focus, try opening your lens iris and allowing the AGC to drop closer to zero.

- Once the camera appears to be aligned, **Click**, the green alignment  icon to close 2D alignment and then click on the red 1-D alignment icon . You will know when your camera is aligned on the finish line because the 1-D image will be primarily white. See image below for proper 1-D alignment. If you followed the steps closely in 2-D align, the camera should already be aligned in 1-D mode as well:

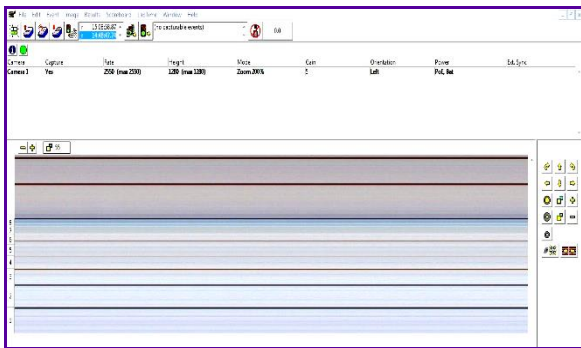

## Step 10: Adjust Primary camera settings

- Click **Camera Settings Icon**  to open the Camera Settings dialog.
- Click to select the **Setup** tab:
  - Name:** enter a name to identify the camera(s)
  - Image Orientation:** select the correct orientation for finish (infield would be Left orientation)
  - Identify By:** select Lane for track **competition**
  - Lanes:** enter the number of lanes on the track; the remaining should be left as default.
- Click to select the **Parameters** tab
  - Rate:** type a value in the field between 800-1000 for sprints (400m and under) or type 600-800 for distance

events. Change this value when moving between sprints and distance races, or else the competitors in your FinishLynx image appear distorted.

Note: Image distortion does not affect timing accuracy.

- Frame Height:** will **vary** by camera models, 640 is recommended for most track competitions;
  - Gain Method:** set to **AGC** for outdoor light and set to **Manual** during the alignment process and for artificial light. Adjust the value based on quality of image in alignment mode.
- Click to select the **Inputs** tab:
    - Start Sensor:** is defaulted to **Closed** for the wired gun start. If **using** the Radiolynx then set **Start Sensor** to **None** to turn off the wired start (they are independent of each other).
    - Photo Eye:** if **using** ACM to stop the scoreboard display, set it to **Internal**.
  - Click to select the **Radiolynx** tab:
    - Port:** select the appropriate port where the Radiolynx **receiver** is plugged into (camera back is common for newer model cameras)
    - Setup ID:** **should** be 000 and select Start Sensor on the next line, **Name:** will fill in automatically with Start 000.
  - Click to select the **Capture** tab:
    - Capture Method:** select **Manual** if using the Capture Button or **Automatic** if using ACM plug-in (both **methods** can be active at the same time by selecting both).
  - Click **OK** to close the **Camera Settings** and it is advised to restart the FinishLynx software.
  - Set White Balance
    - Open a **new** event in FinishLynx by clicking  in the top left corner of the screen.
    - Capture a small amount of image containing a white object, such as a **person** wearing a white t-shirt.
    - Right-click and draw a box around a small amount of the **white** image. You may need to zoom in to the image to do this.
    - Click **Image** from the Menu bar and select **Set | White Balance**.

## Step 11: Setup Reverse Angle camera

Repeat Step 6: through Step 9: for second Vision camera

## Step 12: Create a shared directory for FinishLynx and LynxPad

- Right-click on your computer desktop and select **New | Folder**. When the **New Folder** appears, change the name to **Practice competition**.

- In FinishLynx, click **File | Options....** Click the **Browse** button on the **Event Directory:** and navigate to the **Practice competition** directory you just created. Then, click **Ok**.
- Still in FinishLynx, click **File | Options...** and click the **Database** tab. Click the **Browse...** button next to the **Output Directory:** and navigate to the **Practice competition** directory. Then, click **Ok**.
- Now, start LynxPad by clicking the Windows **Start** button and then **All Programs | LynxPad**.
- Click **File | Options...** and **uncheck** the **Load Existing Results on Program Start** box. Then, click **Ok**.
- Open the sample competition by clicking **File | Open**. Navigate to **C:\LynxPadData\Sample** and then double-click the **lynx.cmp** file. A practice competition opens on the screen.
- Still in LynxPad, click **File | Options....** Click the **Browse** button next to the **Directory:** text field. Navigate to the **Practice competition** file you created earlier. Select it and click **Ok**. Click **Apply** and then click **Ok** again.
- Still in LynxPad, click **File | Save as...** and navigate to the **Practice competition** folder. Then, click **Ok**. Now, FinishLynx can get start lists created in LynxPad, and LynxPad can import results generated by FinishLynx.

### Step 13: Mount & Install IdentiLynx camera

Follow the instructions on the separate IdentiLynx QSG.

### Step 14: Setup RadioLynx wireless start

Follow the instructions on the separate RadioLynx QSG.

### Step 15: Connect the Wind Gauge & Display

- Connect the serial data cable supplied with the Wind Gauge to the DB9 port marked **Serial** on the SerialLynx unit.
- Connect an Ethernet cable between the Ethernet port on the SerialLynx unit and **Port 5** on your Hub
- Connect Wind Gauge 12v cables to the SerialLynx Battery Pack
- Connect the serial data cable supplied with the display to the DB9 port marked **Display** on the SerialLynx unit
- Open the FinishLynx software.
- Power on the MicroTab LED display.

**NOTE:** if connecting either device to your computer using a USB to Serial Adapter, plug it into the USB port before booting FinishLynx software.

### Step 16: Configure Scoreboard Settings

- Go to **File|Options** and select the **Scoreboard** tab from the options window.
- Click on **New** to create a scoreboard or new scoreboard listing in the status window.
- Click on the dropdown for **Script** and select the **uTabLED.lss** from the list (alphabetical listing)

- In the text box for **Name**, type in **uTab LED** (or anything to help you identify each board if there are multiple listings).
- Code Set should be left as Single Byte
- In the Serial Port drop-down list , click to select **Network (Connect)**
- Enter the Port and IP Address settings that refer to Display on the label on your SerialLynx unit.
- For **Running Time** click the radio button for **Auto** and the other settings for running time can be left with the default.
- For **Results** select the following settings:
  - Auto**
  - Always send place**
  - Paging**
  - Size set to 1**
  - Max should** be limited (**3-8** results)
  - Time** – how long info displays
- Click **OK** to close the Options window.
- Close the FinishLynx program and re-start the software. If the camera was booted, it will come back when you re-start the software.
- Go to **File|Options** and select the Scoreboard tab and verify that status now says running.
- Click **OK** to close the Options window
- Using the menu bar at the top of the FinishLynx software, click on **Scoreboard** and then select **Show Time of Day**. A check mark should appear next to Show Time of Day and the time should now display on the board.
- Click on Scoreboard again from the Menu Bar and then select Show Time of Day again and it will remove the check mark and stop the output to the scoreboard.
- Go to **File|Open** and select the Boys3000 from the Lynx directory
- The top 3 (Max) results should page through the display and change the information displayed every 5 seconds (Time)

### Step 17: Setup Wind Gauge

- In FinishLynx, go to **File|Options**
- Select the **Wind** tab.
- From the **Wind Module:** drop-down list, click to select **Lynx** Then, click **Ok**.
- In the **Serial Port** drop-down list , click to select **Network (Connect)**
- Enter the **Port** and **IP Address** settings that are on the label on your SerialLynx unit.
- In the **Default Mode** drop-down list , click to select **100M**
- Click **Ok**.
- Exit FinishLynx and then restart it to save the settings

## Step 18: Automatic Capture Module (ACM) Setup and Operation

### A: Using ACM to Stop Running Time

The following information will help to setup the ACM feature for stopping or pausing the running time with each race.

1. In the Hardware Control window, click on the **Camera Settings** (blue circle with white "1" in upper left).
2. In the Camera Settings, click on the **Inputs** tab and set **Photo Eye** to **Internal**.
3. Next, click on the **Capture** tab and set **Capture Method** to **Automatic**.
4. Click **OK** and close the Camera Settings.
5. Click on **File | Options** and then select the **Scoreboard** tab.
6. Confirm that the scoreboard is setup properly as show above.

### B: Manually Control ACM:

1. Click on **File | New** to create a new blank event or click on the **Create New Blank Event** button in the upper left.
2. In the Event Window make sure there is an **A** for Armed and **S** for Scoreboard and it says **Armed** to the right of the race clock (when using ACM the C for capture will not show until capture is enabled).
3. Create a start for the event and confirm that the running time is showing on the uTabLED display.
4. Click the Capture icon to enable capture and then hit the **Ctrl+F** keys and it will say **Finishing** to the right of the race clock (click on Scoreboard Menu for shortcut keys).
5. Have someone run through the finish line and the camera should capture image and the running time should stop and display the time to the hundredths.

**NOTE:** In multi-lap races you can use **Alt+P** to pause the running time as competitors pass in front of the camera.

### C: Automatic ACM Setting:

**NOTE:** Autobreak settings will occur automatically for every race so play with your settings to make sure it fits the way you want to handle each race, even multi-lap races.

1. Go to **File | Options** and select the Scoreboard tab.
2. Under Running Time on the third line is **Autobreak**, these settings allow it to occur automatically.
3. Selecting **Finish** and **If Capturing** will cause the running time to stop when ACM is on and the competitors cross the finish line.
4. Selecting **Pause** but NOT **If Capturing** will cause the running time to Pause each time competitors cross the finish line in multi-lap races when capture is not enabled.

## Step 19: Use FinishLynx with LynxPad Data



1. In FinishLynx, click  to load the schedule of events from LynxPad. The **Go To Event** dialog appears.
2. Click the **Load Schedule** button once. Click the drop-down list under the **Load Schedule** button. A list of events appears. Click to select the "**110 Meter Hurdles Men (9, 3, 1)**" event in the list, and then click **Ok**. The first heat of the third round of the men's 110m hurdles opens on the FinishLynx screen.
3. Either use a starting gun, or knock the sensor sharply against a hard object - this simulates the firing of the starting gun and starts the yellow FinishLynx timer.



4. Have your assistant run through the finish line while you press down and hold the red capture button to capture the image. Release the button as soon as he/she has run completely through the finish line.
5. Practice evaluating the image by following the same steps you followed earlier in Step 3:
6. Click **File | Save** to save the race to the **Practice competition** directory.
7. Crop space between competitors in your FinishLynx image by right-clicking and drawing a box around the unwanted space. Release the mouse button and select **Crop** from the dialog that appears.
8. **(Optional)** Print the results and a portion of the FinishLynx image by right-clicking on the image and drawing a box around the portion you want to appear in your printout. For example, the first place finisher or a close finish between two competitors. Click **Ok** and then select the printer from the **Print** dialog to send the image with results to the printer.
9. Click **File | Close window** and then click **Yes** to save changes you made to the FinishLynx image when you cropped it.
10. In LynxPad, click to highlight **Men 110 Meter Hurdles** in the **Events** window. The start list appears in the **Heats** window.
11. Still in LynxPad, click **Competition | Refresh All Results**. The results from the race you just evaluated appear in LynxPad.

**This completes the FinishLynx Championship Elite System Quick Start Guide.**

Looking for more resources? Visit our YouTube Channel for setup and support videos.

<https://www.youtube.com/user/LynxSystemDevelopers/>